



Index



Einbaustrahler & LED Module

5



Deckeneinbauleuchten

51



Möbeleinbauleuchten

97



Wandeinbauleuchten

105



Halbeinbauleuchten

111



Anbauleuchten 230V

125



Pendelleuchten 230V

147



Schienenstrahler

153



Aussenstrahler

181



Konverter & Zubehör

187



00 – Weiss matt



01 – weiss

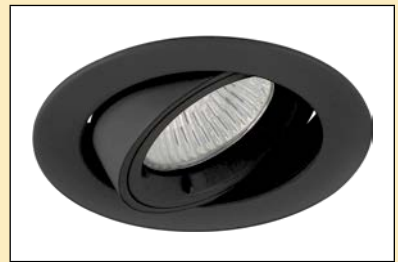

02 – schwarz matt



22 – schwarz glanz



03 – Gold



04 – chrom



05 – nickel satin



09 – chrommatt



11 – alu satin



6 5484



7 5435



8 5635



9 5684



10 5437



11 5638

Einbaustrahler & LED Module



12 5685



13 5674



15 5646



17 58046



18 58038



19 5838



20 5846



21 5846-SQ2



21 5846-SQ3



22 5884



22 5885



23 5681



24 5680



25 5682



26 5643MD



27 5644MD



28 5641



28 5642



29 5624



29 5690



30 5640



30 5636



31 5438



31 5446



32 59010



33 59015



35 5649



35 5648



36 56048



37 5654



37 5444/5454



38 5910



38 5912



39 5913



39 5914



40 5688



41 740018

GU10 Retrofit



41

OSRAM/PHILIPS



42 740040 / 41

6.2W LED



43 740042 / 43

9.2W LED



44 740044 / 45

12.4W LED



45 740044 / 45

13W Dim to Warm



47 59125



47 59126



48 58146



48 58246



49 740025



49 740027

5484 Einbaustrahler / 5484 - SET



Für Leuchtmittel Bauform	PAR16 und LED Retrofit ø50mm (bitte dazu bestellen)
Fassung	GU10 Fassung separat bestellen
Schutzart	IP 20
Schutzklasse	III
Material Gehäuse	Aluminium Druckguss
Einbau	Blattfedern
Ausschnitt / Einbautiefe	AS ø60mm / ET 130
Massangaben	ø84mm

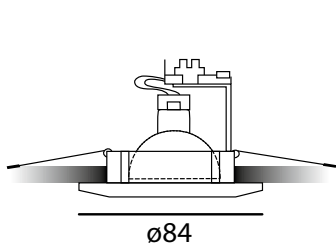

5484-01	<input type="checkbox"/> weiss	16.00 CHF
5484-02	<input checked="" type="checkbox"/> schwarz matt	16.00 CHF
5484-03	<input checked="" type="checkbox"/> gold	20.00 CHF
5484-04	<input type="checkbox"/> chrom	20.00 CHF
5484-05	<input type="checkbox"/> nickel satin	20.00 CHF
5484-09	<input type="checkbox"/> chrommatt	20.00 CHF
5484-11	<input type="checkbox"/> alu satin	20.00 CHF

Zubehör

56001	GU10 Fassung ohne Klemmbügel sonderisoliert	6.50 CHF
56003	GU10 Fassung mit Klemmbügel sonderisoliert	8.00 CHF

Alle Preise excl. VRG, MwSt. und Leuchtmittel.

5484 GU10 LED SET

5W
230V AC



5484
1 × Einbaustrahler



1 × GU10 LEDspot
5W – 2700K oder 3000K
Abstrahlwinkel 38° | Dimmbar [R, C]



1 × GU10 HV-Fassung

5484 – 230V GU10 LED Set

<input type="checkbox"/> weiss	29.00 CHF	<input type="checkbox"/> nickel satin	31.00 CHF
<input checked="" type="checkbox"/> schwarz matt	29.00 CHF	<input type="checkbox"/> chrommatt	31.00 CHF
<input checked="" type="checkbox"/> gold	31.00 CHF	<input type="checkbox"/> alu satin	31.00 CHF
<input type="checkbox"/> chrom	31.00 CHF		

2700K **3000K**

5484 LED SET

6W
350mA



5484
1 × Einbaustrahler



1 × 350mA LED Modul
6W – 2700K, 3000K oder 4000K
Abstrahlwinkel 40° oder 60°



1 × 350mA | 4–9W
LED Converter
Dimmbar [R, C]

5484 – LED Modul Set

<input type="checkbox"/> weiss	78.00 CHF	<input type="checkbox"/> nickel satin	81.00 CHF
<input checked="" type="checkbox"/> schwarz matt	78.00 CHF	<input type="checkbox"/> chrommatt	81.00 CHF
<input checked="" type="checkbox"/> gold	81.00 CHF	<input type="checkbox"/> alu satin	81.00 CHF
<input type="checkbox"/> chrom	81.00 CHF		

2700K **3000K** **4000K**

5484 LED SET

9W
500mA



5484
1 × Einbaustrahler



1 × 500mA LED Modul
9W – 2700K, 3000K oder 4000K
Abstrahlwinkel 40° oder 60°



1 × 500mA | 6–12W
LED Converter
Dimmbar [R, C]

5484 – LED Modul Set

<input type="checkbox"/> weiss	81.00 CHF	<input type="checkbox"/> nickel satin	84.00 CHF
<input checked="" type="checkbox"/> schwarz matt	81.00 CHF	<input type="checkbox"/> chrommatt	84.00 CHF
<input checked="" type="checkbox"/> gold	84.00 CHF	<input type="checkbox"/> alu satin	84.00 CHF
<input type="checkbox"/> chrom	84.00 CHF		

2700K **3000K** **4000K**

5484 Dim to Warm LED SET

13W
310mA



5484
1 × Einbaustrahler



1 × 310mA DTW LED Modul
13W – 1800–3000K
Abstrahlwinkel 40° oder 60°



1 × 310mA
LED Converter
Dimmbar [R, C]

5484 – Dim to Warm LED Modul Set

<input type="checkbox"/> weiss	91.00 CHF	<input type="checkbox"/> nickel satin	94.00 CHF
<input checked="" type="checkbox"/> schwarz matt	91.00 CHF	<input type="checkbox"/> chrommatt	94.00 CHF
<input checked="" type="checkbox"/> gold	94.00 CHF	<input type="checkbox"/> alu satin	94.00 CHF
<input type="checkbox"/> chrom	94.00 CHF		

1800-3000K

5435 Einbaustrahler / 5435 - SET



Für Leuchtmittel Bauform	PAR16 und LED Retrofit ø50mm (bitte dazu bestellen)
Fassung	GU10 Fassung separat bestellen
Schutzart	IP 20
Schutzklasse	III
Material Gehäuse	Aluminium Druckguss
Dreh- und schwenkbar	— / 30°
Einbau	Spreitzfedern
Ausschnitt / Einbautiefe	AS ø68–70mm / ET 130
Massangaben	ø84mm

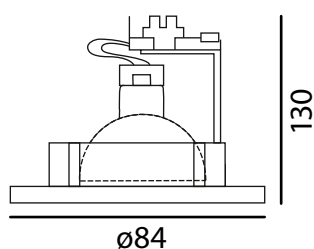

5435-00	<input type="checkbox"/> weiss matt	20.00 CHF
5435-01	<input type="checkbox"/> weiss	20.00 CHF
5435-03	<input checked="" type="checkbox"/> gold	24.00 CHF
5435-04	<input type="checkbox"/> chrom	24.00 CHF
5435-05	<input type="checkbox"/> nickel satin	24.00 CHF
5435-09	<input type="checkbox"/> chrommatt	24.00 CHF
5435-11	<input type="checkbox"/> alu satin	24.00 CHF

Zubehör

56001	GU10 Fassung ohne Klemmbügel sonderisoliert	6.50 CHF
56003	GU10 Fassung mit Klemmbügel sonderisoliert	8.00 CHF

Alle Preise excl. VRG, MwSt. und Leuchtmittel.

5435 GU10 LED SET

5W
230V AC



5435
1 × Einbaustrahler



1 × GU10 LEDspot
5W – 2700K oder 3000K
Abstrahlwinkel 38° | Dimmbar [R, C]



1 × GU10 HV-Fassung

5435 – 230V GU10 LED Set

<input type="checkbox"/> weiss matt	33.00 CHF	<input type="checkbox"/> nickel satin	35.00 CHF
<input type="checkbox"/> weiss	33.00 CHF	<input type="checkbox"/> chrommatt	35.00 CHF
<input checked="" type="checkbox"/> gold	35.00 CHF	<input type="checkbox"/> alu satin	35.00 CHF
<input type="checkbox"/> chrom	35.00 CHF		

2700K 3000K

5435 LED SET

6W
350mA



5435
1 × Einbaustrahler



1 × 350mA LED Modul
6W – 2700K, 3000K oder 4000K
Abstrahlwinkel 40° oder 60°



1 × 350mA | 4–9W
LED Konverter
Dimmbar [R, C]

5435 – LED Modul Set

<input type="checkbox"/> weiss matt	82.00 CHF	<input type="checkbox"/> nickel satin	85.00 CHF
<input type="checkbox"/> weiss	82.00 CHF	<input type="checkbox"/> chrommatt	85.00 CHF
<input checked="" type="checkbox"/> gold	85.00 CHF	<input type="checkbox"/> alu satin	85.00 CHF
<input type="checkbox"/> chrom	85.00 CHF		

2700K 3000K 4000K

5435 LED SET

9W
500mA



5435
1 × Einbaustrahler



1 × 500mA LED Modul
9W – 2700K, 3000K oder 4000K
Abstrahlwinkel 40° oder 60°



1 × 500mA | 6–12W
LED Konverter
Dimmbar [R, C]

5435 – LED Modul Set

<input type="checkbox"/> weiss matt	85.00 CHF	<input type="checkbox"/> nickel satin	88.00 CHF
<input type="checkbox"/> weiss	85.00 CHF	<input type="checkbox"/> chrommatt	88.00 CHF
<input checked="" type="checkbox"/> gold	88.00 CHF	<input type="checkbox"/> alu satin	88.00 CHF
<input type="checkbox"/> chrom	88.00 CHF		

2700K 3000K 4000K

5435 Dim to Warm LED SET

13W
310mA



5435
1 × Einbaustrahler



1 × 310mA **DTW** LED Modul
13W – 1800–3000K
Abstrahlwinkel 40° oder 60°



1 × 310mA
LED Konverter
Dimmbar [R, C]

5435 – Dim to Warm LED Modul Set

<input type="checkbox"/> weiss matt	95.00 CHF	<input type="checkbox"/> nickel satin	98.00 CHF
<input type="checkbox"/> weiss	95.00 CHF	<input type="checkbox"/> chrommatt	98.00 CHF
<input checked="" type="checkbox"/> gold	98.00 CHF	<input type="checkbox"/> alu satin	98.00 CHF
<input type="checkbox"/> chrom	98.00 CHF		

1800-3000K

5635 Einbaustrahler / 5635 - SET



Für Leuchtmittel Bauform	PAR16 und LED Retrofit ø50mm (bitte dazu bestellen)
Fassung	GU10 Fassung separat bestellen
Schutzart	IP 20
Schutzklasse	III
Material Gehäuse	Aluminium Druckguss
Schwenkbar	30°
Ausschnitt / Einbautiefe	AS ø68-70mm / ET 130
Massangaben	ø90mm

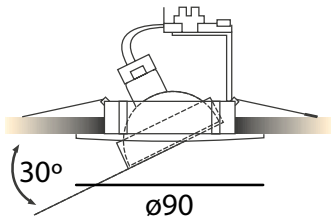

	mit Blattfedern	mit Spreizfedern		
130	5635-01B	5635-01S	<input type="checkbox"/> weiss	20.00 CHF
	5635-02B	—	<input checked="" type="checkbox"/> schwarz matt	20.00 CHF
	5635-22B	—	<input checked="" type="checkbox"/> schwarz glanz	20.00 CHF
	5635-03B	5635-03S	<input checked="" type="checkbox"/> gold	24.00 CHF
	5635-04B	5635-04S	<input type="checkbox"/> chrom	24.00 CHF
	5635-05B	5635-05S	<input type="checkbox"/> nickel satin	24.00 CHF
	5635-09B	5635-09S	<input type="checkbox"/> chrommatt	24.00 CHF
	5635-11B	5635-11S	<input type="checkbox"/> alu satin	24.00 CHF

Zubehör

56001	GU10 Fassung ohne Klemmbügel sonderisoliert	6.50 CHF
56003	GU10 Fassung mit Klemmbügel sonderisoliert	8.00 CHF

Alle Preise excl. VRG, MwSt. und Leuchtmittel.

5635 GU10 LED SET

5W
230V AC



5635
1 × Einbaustrahler



1 × GU10 LEDspot
5W – 2700K oder 3000K
Abstrahlwinkel 38° | Dimmbar [R, C]



1 × GU10 HV-Fassung

5635 – 230V GU10 LED Set

<input type="checkbox"/> weiss	33.00 CHF	<input type="checkbox"/> nickel satin	35.00 CHF
<input checked="" type="checkbox"/> schwarz	33.00 CHF	<input type="checkbox"/> chrommatt	35.00 CHF
<input checked="" type="checkbox"/> gold	35.00 CHF	<input type="checkbox"/> alu satin	35.00 CHF
<input type="checkbox"/> chrom	35.00 CHF		

2700K **3000K**

5635 LED SET

6W
350mA



5635
1 × Einbaustrahler



1 × 350mA LED Modul
6W – 2700K, 3000K oder 4000K
Abstrahlwinkel 40° oder 60°



1 × 350mA | 4–9W
LED Converter
Dimmbar [R, C]

5635 – LED Modul Set

<input type="checkbox"/> weiss	82.00 CHF	<input type="checkbox"/> nickel satin	85.00 CHF
<input checked="" type="checkbox"/> schwarz	82.00 CHF	<input type="checkbox"/> chrommatt	85.00 CHF
<input checked="" type="checkbox"/> gold	85.00 CHF	<input type="checkbox"/> alu satin	85.00 CHF
<input type="checkbox"/> chrom	85.00 CHF		

2700K **3000K** **4000K**

5635 LED SET

9W
500mA



5635
1 × Einbaustrahler



1 × 500mA LED Modul
9W – 2700K, 3000K oder 4000K
Abstrahlwinkel 40° oder 60°



1 × 500mA | 6–12W
LED Converter
Dimmbar [R, C]

5635 – LED Modul Set

<input type="checkbox"/> weiss	85.00 CHF	<input type="checkbox"/> nickel satin	88.00 CHF
<input checked="" type="checkbox"/> schwarz	85.00 CHF	<input type="checkbox"/> chrommatt	88.00 CHF
<input checked="" type="checkbox"/> gold	88.00 CHF	<input type="checkbox"/> alu satin	88.00 CHF
<input type="checkbox"/> chrom	88.00 CHF		

2700K **3000K** **4000K**

5635 Dim to Warm LED SET

13W
310mA



5635
1 × Einbaustrahler



1 × 310mA DTW LED Modul
13W – 1800–3000K
Abstrahlwinkel 40° oder 60°



1 × 310mA
LED Converter
Dimmbar [R, C]

5635 – Dim to Warm LED Modul Set

<input type="checkbox"/> weiss	95.00 CHF	<input type="checkbox"/> nickel satin	98.00 CHF
<input checked="" type="checkbox"/> schwarz	95.00 CHF	<input type="checkbox"/> chrommatt	98.00 CHF
<input checked="" type="checkbox"/> gold	98.00 CHF	<input type="checkbox"/> alu satin	98.00 CHF
<input type="checkbox"/> chrom	98.00 CHF		

1800-3000K

5684 Einbaustrahler / 5684 - SET



Für Leuchtmittel Bauform	PAR16 und LED Retrofit ø50mm (bitte dazu bestellen)
Fassung	GU10 Fassung separat bestellen
Schutzart	IP 20
Schutzklasse	III
Material Gehäuse	Aluminium Druckguss
Einbau	Blattfedern
Ausschnitt / Einbautiefe	AS ø68-70mm / ET 130
Massangaben	ø84mm

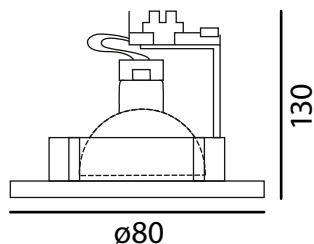
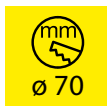

5684-00	<input type="checkbox"/> weiss matt	20.00 CHF
5684-01	<input type="checkbox"/> weiss	20.00 CHF
5684-22	<input type="checkbox"/> schwarz glanz	20.00 CHF
5684-03	<input type="checkbox"/> gold	24.00 CHF
5684-04	<input type="checkbox"/> chrom	24.00 CHF
5684-05	<input type="checkbox"/> nickel satin	24.00 CHF
5684-09	<input type="checkbox"/> chrommatt	24.00 CHF
5684-11	<input type="checkbox"/> alu satin	24.00 CHF

Zubehör		
56001	GU10 Fassung ohne Klemmbügel sonderisoliert	6.50 CHF
56003	GU10 Fassung mit Klemmbügel sonderisoliert	8.00 CHF

Alle Preise excl. VRG, MwSt. und Leuchtmittel.

5684 GU10 LED SET

5W
230V AC



5684
1 × Einbaustrahler



1 × GU10 LEDspot
5W – 2700K oder 3000K
Abstrahlwinkel 38° | Dimmbar [R, C]



1 × GU10 HV-Fassung

5684 – 230V GU10 LED Set			
<input type="checkbox"/> weiss	33.00 CHF	<input type="checkbox"/> nickel satin	35.00 CHF
<input type="checkbox"/> gold	35.00 CHF	<input type="checkbox"/> chrommatt	35.00 CHF
<input type="checkbox"/> chrom	35.00 CHF	<input type="checkbox"/> alu satin	35.00 CHF

2700K **3000K**

5684 LED SET

6W
350mA



5684
1 × Einbaustrahler



1 × 350mA LED Modul
6W – 2700K, 3000K oder 4000K
Abstrahlwinkel 40° oder 60°



1 × 350mA | 4–9W
LED Konverter
Dimmbar [R, C]

5684 – LED Modul Set			
<input type="checkbox"/> weiss	82.00 CHF	<input type="checkbox"/> nickel satin	85.00 CHF
<input type="checkbox"/> gold	85.00 CHF	<input type="checkbox"/> chrommatt	85.00 CHF
<input type="checkbox"/> chrom	85.00 CHF	<input type="checkbox"/> alu satin	85.00 CHF

2700K **3000K** **4000K**

5684 LED SET

9W
500mA



5684
1 × Einbaustrahler



1 × 500mA LED Modul
9W – 2700K, 3000K oder 4000K
Abstrahlwinkel 40° oder 60°



1 × 500mA | 6–12W
LED Konverter
Dimmbar [R, C]

5684 – LED Modul Set			
<input type="checkbox"/> weiss	85.00 CHF	<input type="checkbox"/> nickel satin	88.00 CHF
<input type="checkbox"/> gold	88.00 CHF	<input type="checkbox"/> chrommatt	88.00 CHF
<input type="checkbox"/> chrom	88.00 CHF	<input type="checkbox"/> alu satin	88.00 CHF

2700K **3000K** **4000K**

5684 Dim to Warm LED SET

13W
310mA



5684
1 × Einbaustrahler



1 × 310mA **DTW** LED Modul
13W – 1800–3000K
Abstrahlwinkel 40° oder 60°



1 × 310mA
LED Konverter
Dimmbar [R, C]

5684 – Dim to Warm LED Modul Set			
<input type="checkbox"/> weiss	95.00 CHF	<input type="checkbox"/> nickel satin	98.00 CHF
<input type="checkbox"/> gold	98.00 CHF	<input type="checkbox"/> chrommatt	98.00 CHF
<input type="checkbox"/> chrom	98.00 CHF	<input type="checkbox"/> alu satin	98.00 CHF

1800-3000K

5437 Einbaustrahler / 5437 - SET



Für Leuchtmittel Bauform	PAR16 und LED Retrofit ø50mm (bitte dazu bestellen)
Fassung	GU10 Fassung separat bestellen
Schutzart	IP 20
Schutzklasse	III
Material Gehäuse	Aluminium Druckguss
Wchwenkbar	30°
Ausschnitt / Einbautiefe	AS ø68-70mm / ET 130
Massangaben	ø81mm

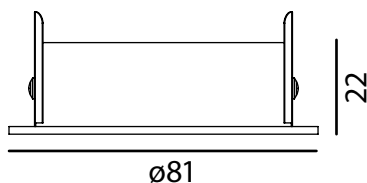

mit Blattfedern	mit Spreizfedern			
5437-00B	5437-00S	<input type="checkbox"/>	weiss matt	24.00 CHF
5437-01B	5437-01S	<input type="checkbox"/>	weiss	24.00 CHF
5437-02B	5437-02S	<input checked="" type="checkbox"/>	schwarz matt	24.00 CHF
5437-03B	5437-03S	<input checked="" type="checkbox"/>	gold	30.00 CHF
5437-04B	5437-04S	<input type="checkbox"/>	chrom	30.00 CHF
5437-05B	5437-05S	<input type="checkbox"/>	nickel satin	30.00 CHF
5437-09B	5437-09S	<input type="checkbox"/>	chrommatt	30.00 CHF
5437-11B	5437-11S	<input type="checkbox"/>	alu satin	30.00 CHF

Zubehör

56001	GU10 Fassung ohne Klemmbügel sonderisoliert	6.50 CHF
56003	GU10 Fassung mit Klemmbügel sonderisoliert	8.00 CHF

Alle Preise excl. VRG, MwSt. und Leuchtmittel.

5437 GU10 LED SET

5W
230V AC



5437
1 × Einbaustrahler



1 × GU10 LEDspot
5W – 2700K oder 3000K
Abstrahlwinkel 38° | Dimmbar [R, C]



1 × GU10 HV-Fassung

5437 – 230V GU10 LED Set

<input type="checkbox"/>	weiss matt	37.00 CHF	<input type="checkbox"/>	chrom	41.00 CHF
<input type="checkbox"/>	weiss	37.00 CHF	<input type="checkbox"/>	nickel satin	41.00 CHF
<input checked="" type="checkbox"/>	schwarz matt	37.00 CHF	<input type="checkbox"/>	chrommatt	41.00 CHF
<input checked="" type="checkbox"/>	gold	41.00 CHF	<input type="checkbox"/>	alu satin	41.00 CHF

2700K **3000K**

5437 LED SET

6W
350mA



5437
1 × Einbaustrahler



1 × 350mA LED Modul
6W – 2700K, 3000K oder 4000K
Abstrahlwinkel 40° oder 60°



1 × 350mA | 4–9W
LED Converter
Dimmbar [R, C]

5437 – LED Modul Set

<input type="checkbox"/>	weiss matt	86.00 CHF	<input type="checkbox"/>	chrom	91.00 CHF
<input type="checkbox"/>	weiss	86.00 CHF	<input type="checkbox"/>	nickel satin	91.00 CHF
<input checked="" type="checkbox"/>	schwarz matt	86.00 CHF	<input type="checkbox"/>	chrommatt	91.00 CHF
<input checked="" type="checkbox"/>	gold	91.00 CHF	<input type="checkbox"/>	alu satin	91.00 CHF

2700K **3000K** **4000K**

5437 LED SET

9W
500mA



5437
1 × Einbaustrahler



1 × 500mA LED Modul
9W – 2700K, 3000K oder 4000K
Abstrahlwinkel 40° oder 60°



1 × 500mA | 6–12W
LED Converter
Dimmbar [R, C]

5437 – LED Modul Set

<input type="checkbox"/>	weiss matt	89.00 CHF	<input type="checkbox"/>	chrom	94.00 CHF
<input type="checkbox"/>	weiss	89.00 CHF	<input type="checkbox"/>	nickel satin	94.00 CHF
<input checked="" type="checkbox"/>	schwarz matt	89.00 CHF	<input type="checkbox"/>	chrommatt	94.00 CHF
<input checked="" type="checkbox"/>	gold	94.00 CHF	<input type="checkbox"/>	alu satin	94.00 CHF

2700K **3000K** **4000K**

5437 Dim to Warm LED SET

13W
310mA



5437
1 × Einbaustrahler



1 × 310mA **DTW** LED Modul
13W – 1800–3000K
Abstrahlwinkel 40° oder 60°



1 × 310mA
LED Converter
Dimmbar [R, C]

5437 – Dim to Warm LED Modul Set

<input type="checkbox"/>	weiss matt	99.00 CHF	<input type="checkbox"/>	chrom	104.00 CHF
<input type="checkbox"/>	weiss	99.00 CHF	<input type="checkbox"/>	nickel satin	104.00 CHF
<input checked="" type="checkbox"/>	schwarz matt	99.00 CHF	<input type="checkbox"/>	chrommatt	104.00 CHF
<input checked="" type="checkbox"/>	gold	104.00 CHF	<input type="checkbox"/>	alu satin	104.00 CHF

1800-3000K

5638 Einbaustrahler / 5638 - SET



Für Leuchtmittel Bauform	PAR16 und LED Retrofit ø50mm (bitte dazu bestellen)
Fassung	GU10 Fassung separat bestellen
Schutzart	IP 20
Schutzklasse	III
Material Gehäuse	Aluminium Druckguss
Schwenkbar	30°
Einbau	Blattfedern
Ausschnitt / Einbautiefe	AS ø80mm / ET 130
Massangaben	ø95mm

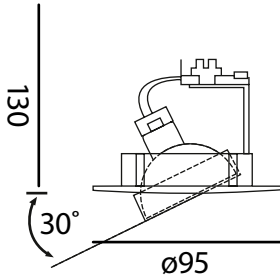

5638-00	<input type="checkbox"/> weiss matt	24.00 CHF
5638-01	<input type="checkbox"/> weiss	24.00 CHF
5638-02	<input type="checkbox"/> schwarz matt	24.00 CHF
5638-22	<input type="checkbox"/> schwarz glanz	24.00 CHF
5638-03	<input type="checkbox"/> gold	30.00 CHF
5638-04	<input type="checkbox"/> chrom	30.00 CHF
5638-05	<input type="checkbox"/> nickel satin	30.00 CHF
5638-09	<input type="checkbox"/> chrommatt	30.00 CHF
5638-11	<input type="checkbox"/> alu satin	30.00 CHF

Zubehör

56001	GU10 Fassung ohne Klemmbügel sonderisoliert	6.50 CHF
56003	GU10 Fassung mit Klemmbügel sonderisoliert	8.00 CHF

Alle Preise excl. VRG, MwSt. und Leuchtmittel.

5638 GU10 LED SET

5W
230V AC



5638
1 × Einbaustrahler



1 × GU10 LEDspot
5W – 2700K oder 3000K
Abstrahlwinkel 38° | Dimmbar [R, C]



1 × GU10 HV-Fassung

5638 – 230V GU10 LED Set

<input type="checkbox"/> weiss matt	37.00 CHF	<input type="checkbox"/> chrom	41.00 CHF
<input type="checkbox"/> weiss	37.00 CHF	<input type="checkbox"/> nickel satin	41.00 CHF
<input type="checkbox"/> schwarz	37.00 CHF	<input type="checkbox"/> chrommatt	41.00 CHF
<input type="checkbox"/> gold	41.00 CHF	<input type="checkbox"/> alu satin	41.00 CHF

2700K 3000K

5638 LED SET

6W
350mA



5638
1 × Einbaustrahler



1 × 350mA LED Modul
6W – 2700K, 3000K oder 4000K
Abstrahlwinkel 40° oder 60°



1 × 350mA | 4–9W
LED Konverter
Dimmbar [R, C]

5638 – LED Modul Set

<input type="checkbox"/> weiss matt	86.00 CHF	<input type="checkbox"/> chrom	91.00 CHF
<input type="checkbox"/> weiss	86.00 CHF	<input type="checkbox"/> nickel satin	91.00 CHF
<input type="checkbox"/> schwarz	86.00 CHF	<input type="checkbox"/> chrommatt	91.00 CHF
<input type="checkbox"/> gold	91.00 CHF	<input type="checkbox"/> alu satin	91.00 CHF

2700K 3000K 4000K

5638 LED SET

9W
500mA



5638
1 × Einbaustrahler



1 × 500mA LED Modul
9W – 2700K, 3000K oder 4000K
Abstrahlwinkel 40° oder 60°



1 × 500mA | 6–12W
LED Konverter
Dimmbar [R, C]

5638 – LED Modul Set

<input type="checkbox"/> weiss matt	89.00 CHF	<input type="checkbox"/> chrom	94.00 CHF
<input type="checkbox"/> weiss	89.00 CHF	<input type="checkbox"/> nickel satin	94.00 CHF
<input type="checkbox"/> schwarz	89.00 CHF	<input type="checkbox"/> chrommatt	94.00 CHF
<input type="checkbox"/> gold	94.00 CHF	<input type="checkbox"/> alu satin	94.00 CHF

2700K 3000K 4000K

5638 Dim to Warm LED SET

13W
310mA



5638
1 × Einbaustrahler



1 × 310mA DTW LED Modul
13W – 1800–3000K
Abstrahlwinkel 40° oder 60°



1 × 310mA
LED Konverter
Dimmbar [R, C]

5638 – Dim to Warm LED Modul Set

<input type="checkbox"/> weiss matt	99.00 CHF	<input type="checkbox"/> chrom	104.00 CHF
<input type="checkbox"/> weiss	99.00 CHF	<input type="checkbox"/> nickel satin	104.00 CHF
<input type="checkbox"/> schwarz	99.00 CHF	<input type="checkbox"/> chrommatt	104.00 CHF
<input type="checkbox"/> gold	104.00 CHF	<input type="checkbox"/> alu satin	104.00 CHF

1800-3000K

5685 Einbaustrahler / 5685 -SET



Für Leuchtmittel Bauform	PAR16 und LED Retrofit ø50mm (bitte dazu bestellen)
Fassung	GU10 Fassung separat bestellen
Schutzart	IP 20
Schutzklasse	III
Material Gehäuse	Aluminium Druckguss
Einbau	Blattfedern
Ausschnitt / Einbautiefe	AS ø68-70mm / ET 130
Massangaben	80 × 80mm

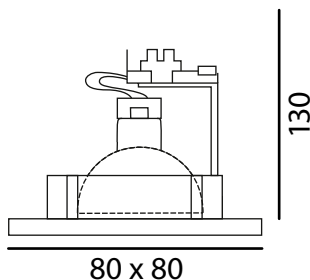

5685-01	weiss	28.00 CHF
5685-03	gold	34.00 CHF
5685-04	chrom	34.00 CHF
5685-05	nickel satin	34.00 CHF
5685-09	chrommatt	34.00 CHF
5685-11	alu satin	34.00 CHF

Zubehör

56001	GU10 Fassung ohne Klemmbügel sonderisoliert	6.50 CHF
56003	GU10 Fassung mit Klemmbügel sonderisoliert	8.00 CHF

Alle Preise excl. VRG, MwSt. und Leuchtmittel.

5685 GU10 LED SET

5W
230V AC



5685
1 × Einbaustrahler



1 × GU10 LEDspot
5W – 2700K oder 3000K
Abstrahlwinkel 38° | Dimmbar [R, C]



1 × GU10 HV-Fassung

5685 – 230V GU10 LED Set

weiss	41.00 CHF	nickel satin	45.00 CHF
gold	45.00 CHF	chrommatt	45.00 CHF
chrom	45.00 CHF	alu satin	45.00 CHF

2700K **3000K**

5685 LED SET

6W
350mA



5685
1 × Einbaustrahler



1 × 350mA LED Modul
6W – 2700K, 3000K oder 4000K
Abstrahlwinkel 40° oder 60°



1 × 350mA | 4–9W
LED Converter
Dimmbar [R, C]

5685 – LED Modul Set

weiss	90.00 CHF	nickel satin	95.00 CHF
gold	95.00 CHF	chrommatt	95.00 CHF
chrom	95.00 CHF	alu satin	95.00 CHF

2700K **3000K** **4000K**

5685 LED SET

9W
500mA



5685
1 × Einbaustrahler



1 × 500mA LED Modul
9W – 2700K, 3000K oder 4000K
Abstrahlwinkel 40° oder 60°



1 × 500mA | 6–12W
LED Converter
Dimmbar [R, C]

5685 – LED Modul Set

weiss	93.00 CHF	nickel satin	98.00 CHF
gold	98.00 CHF	chrommatt	98.00 CHF
chrom	98.00 CHF	alu satin	98.00 CHF

2700K **3000K** **4000K**

5685 Dim to Warm LED SET

13W
310mA



5685
1 × Einbaustrahler



1 × 310mA DTW LED Modul
13W – 1800–3000K
Abstrahlwinkel 40° oder 60°



1 × 310mA
LED Converter
Dimmbar [R, C]

5685 – Dim to Warm LED Modul Set

weiss	103.00 CHF	nickel satin	108.00 CHF
gold	108.00 CHF	chrommatt	108.00 CHF
chrom	108.00 CHF	alu satin	108.00 CHF

1800-3000K

5674 Einbaustrahler / 5674 - SET



Für Leuchtmittel Bauform	PAR16 und LED Retrofit ø50mm (bitte dazu bestellen)
Fassung	GU10 Fassung separat bestellen
Schutzart	IP 20
Schutzklasse	III
Material Gehäuse	Aluminium Druckguss
Schwenkbar	30°
Einbau	Blattfedern
Ausschnitt / Einbautiefe	AS ø68-70mm / ET 130
Massangaben	82 x 82mm

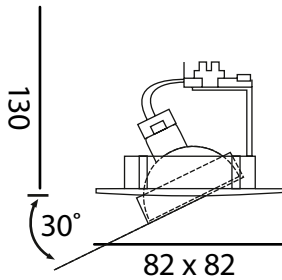

5674-01	<input type="checkbox"/> weiss	36.00 CHF
5674-03	<input type="checkbox"/> gold	44.00 CHF
5674-04	<input type="checkbox"/> chrom	44.00 CHF
5674-05	<input type="checkbox"/> nickel satin	44.00 CHF
5674-09	<input type="checkbox"/> chrommatt	44.00 CHF
5674-11	<input type="checkbox"/> alu satin	44.00 CHF

Zubehör

56001	GU10 Fassung ohne Klemmbügel sonderisoliert	6.50 CHF
56003	GU10 Fassung mit Klemmbügel sonderisoliert	8.00 CHF

Alle Preise excl. VRG, MwSt. und Leuchtmittel.

5674 GU10 LED SET

5W
230V AC



5674
1 x Einbaustrahler



1 x GU10 LEDspot
5W – 2700K oder 3000K
Abstrahlwinkel 38° | Dimmbar [R, C]



1 x GU10 HV-Fassung

5674 – 230V GU10 LED Set

<input type="checkbox"/> weiss	49.00 CHF	<input type="checkbox"/> nickel satin	55.00 CHF
<input type="checkbox"/> gold	55.00 CHF	<input type="checkbox"/> chrommatt	55.00 CHF
<input type="checkbox"/> chrom	55.00 CHF	<input type="checkbox"/> alu satin	55.00 CHF

2700K **3000K**

5674 LED SET

6W
350mA



5674
1 x Einbaustrahler



1 x 350mA LED Modul
6W – 2700K, 3000K oder 4000K
Abstrahlwinkel 40° oder 60°



1 x 350mA | 4-9W
LED Konverter
Dimmbar [R, C]

5674 – LED Modul Set

<input type="checkbox"/> weiss	98.00 CHF	<input type="checkbox"/> nickel satin	105.00 CHF
<input type="checkbox"/> gold	105.00 CHF	<input type="checkbox"/> chrommatt	105.00 CHF
<input type="checkbox"/> chrom	105.00 CHF	<input type="checkbox"/> alu satin	105.00 CHF

2700K **3000K** **4000K**

5674 LED SET

9W
500mA



5674
1 x Einbaustrahler



1 x 500mA LED Modul
9W – 2700K, 3000K oder 4000K
Abstrahlwinkel 40° oder 60°



1 x 500mA | 6-12W
LED Konverter
Dimmbar [R, C]

5674 – LED Modul Set

<input type="checkbox"/> weiss	101.00 CHF	<input type="checkbox"/> nickel satin	108.00 CHF
<input type="checkbox"/> gold	108.00 CHF	<input type="checkbox"/> chrommatt	108.00 CHF
<input type="checkbox"/> chrom	108.00 CHF	<input type="checkbox"/> alu satin	108.00 CHF

2700K **3000K** **4000K**

5674 Dim to Warm LED SET

13W
310mA



5674
1 x Einbaustrahler



1 x 310mA **DTW** LED Modul
13W – 1800-3000K
Abstrahlwinkel 40° oder 60°



1 x 310mA
LED Konverter
Dimmbar [R, C]

5674 – Dim to Warm LED Modul Set

<input type="checkbox"/> weiss	111.00 CHF	<input type="checkbox"/> nickel satin	118.00 CHF
<input type="checkbox"/> gold	118.00 CHF	<input type="checkbox"/> chrommatt	118.00 CHF
<input type="checkbox"/> chrom	118.00 CHF	<input type="checkbox"/> alu satin	118.00 CHF

1800-3000K



5646 Einbaustrahler / 5646 - SET



Für Leuchtmittel Bauform	PAR16 und LED Retrofit ø50mm (bitte dazu bestellen)
Fassung	GU10 Fassung separat bestellen
Schutzart	IP 20
Schutzklasse	III
Material Gehäuse	Aluminium Druckguss
Schwenkbar	30°
Einbau	Blattfeder
Ausschnitt / Einbautiefe	AS ø80mm / ET 130
Massangaben	95 x 95mm

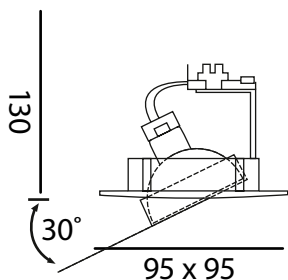

5646-00	<input type="checkbox"/> weiss matt	36.00 CHF
5646-01	<input type="checkbox"/> weiss	36.00 CHF
5646-03	<input checked="" type="checkbox"/> gold	44.00 CHF
5646-04	<input type="checkbox"/> chrom	44.00 CHF
5646-05	<input type="checkbox"/> nickel satin	44.00 CHF
5646-09	<input type="checkbox"/> chrommatt	44.00 CHF
5646-11	<input type="checkbox"/> alu satin	44.00 CHF

Zubehör

56001	GU10 Fassung ohne Klemmbügel sonderisoliert	6.50 CHF
56003	GU10 Fassung mit Klemmbügel sonderisoliert	8.00 CHF

Alle Preise excl. VRG, MwSt. und Leuchtmittel.

5646 GU10 LED SET

5W
230V AC



5646
1 x Einbaustrahler



1 x GU10 LEDspot
5W – 2700K oder 3000K
Abstrahlwinkel 38° | Dimmbar [R, C]



1 x GU10 HV-Fassung

5646 – 230V GU10 LED Set

<input type="checkbox"/> weiss matt	49.00 CHF	<input type="checkbox"/> nickel satin	55.00 CHF
<input type="checkbox"/> weiss	49.00 CHF	<input type="checkbox"/> chrommatt	55.00 CHF
<input checked="" type="checkbox"/> gold	55.00 CHF	<input type="checkbox"/> alu satin	55.00 CHF
<input type="checkbox"/> chrom	55.00 CHF		

2700K **3000K**

5646 LED SET

6W
350mA



5646
1 x Einbaustrahler



1 x 350mA LED Modul
6W – 2700K, 3000K oder 4000K
Abstrahlwinkel 40° oder 60°



1 x 350mA | 4–9W
LED Konverter
Dimmbar [R, C]

5646 – LED Modul Set

<input type="checkbox"/> weiss matt	98.00 CHF	<input type="checkbox"/> nickel satin	105.00 CHF
<input type="checkbox"/> weiss	98.00 CHF	<input type="checkbox"/> chrommatt	105.00 CHF
<input checked="" type="checkbox"/> gold	105.00 CHF	<input type="checkbox"/> alu satin	105.00 CHF
<input type="checkbox"/> chrom	105.00 CHF		

2700K **3000K** **4000K**

5646 LED SET

9W
500mA



5646
1 x Einbaustrahler



1 x 500mA LED Modul
9W – 2700K, 3000K oder 4000K
Abstrahlwinkel 40° oder 60°



1 x 500mA | 6–12W
LED Konverter
Dimmbar [R, C]

5646 – LED Modul Set

<input type="checkbox"/> weiss matt	101.00 CHF	<input type="checkbox"/> nickel satin	108.00 CHF
<input type="checkbox"/> weiss	101.00 CHF	<input type="checkbox"/> chrommatt	108.00 CHF
<input checked="" type="checkbox"/> gold	108.00 CHF	<input type="checkbox"/> alu satin	108.00 CHF
<input type="checkbox"/> chrom	108.00 CHF		

2700K **3000K** **4000K**

5646 Dim to Warm LED SET

13W
310mA



5646
1 x Einbaustrahler



1 x 310mA **DTW** LED Modul
13W – 1800–3000K
Abstrahlwinkel 40° oder 60°



1 x 310mA
LED Konverter
Dimmbar [R, C]

5646 – Dim to Warm LED Modul Set

<input type="checkbox"/> weiss matt	111.00 CHF	<input type="checkbox"/> nickel satin	118.00 CHF
<input type="checkbox"/> weiss	111.00 CHF	<input type="checkbox"/> chrommatt	118.00 CHF
<input checked="" type="checkbox"/> gold	118.00 CHF	<input type="checkbox"/> alu satin	118.00 CHF
<input type="checkbox"/> chrom	118.00 CHF		

1800-3000K



58046 Einbaustrahler / 58046 - SET



Für Leuchtmittel Bauform	PAR16 und LED Retrofit ø50mm (bitte dazu bestellen)
Fassung	GU10 Fassung separat bestellen
Schutzart	IP 20
Schutzklasse	III
Material Gehäuse	Aluminium Druckguss
Dreh- und schwenkbar	355° / 30°
Einbau	Spreizfedern
Ausschnitt / Einbautiefe	AS ø80mm / ET 130
Massangaben	92 × 92mm

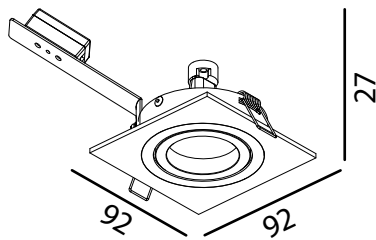

	Farbe	Einbau	
58046-00B	<input type="checkbox"/> weiss matt	Blattfeder	28.00 CHF
58046-00S	<input type="checkbox"/> weiss matt	Spreizfeder	28.00 CHF
58046-16S	<input type="checkbox"/> alu satin	Spreizfeder	34.00 CHF

Zubehör		
56001	GU10 Fassung ohne Klemmbügel sonderisoliert	6.50 CHF
56003	GU10 Fassung mit Klemmbügel sonderisoliert	8.00 CHF

Alle Preise excl. VRG, MwSt. und Leuchtmittel.

58046 GU10 LED SET

5W
230V AC



58046
1 × Einbaustrahler



1 × GU10 LEDspot
5W – 2700K oder 3000K
Abstrahlwinkel 38° | Dimmbar [R, C]



1 × GU10 HV-Fassung

58046 – 230V GU10 LED Set		
<input type="checkbox"/> weiss matt	41.00 CHF	<input type="checkbox"/> alu satin 45.00 CHF

2700K 3000K

58046 LED SET

6W
350mA



58046
1 × Einbaustrahler



1 × 350mA LED Modul
6W – 2700K, 3000K oder 4000K
Abstrahlwinkel 40° oder 60°



1 × 350mA | 4–9W
LED Konverter
Dimmbar [R, C]

58046 – LED Modul Set		
<input type="checkbox"/> weiss matt	90.00 CHF	<input type="checkbox"/> alu satin 95.00 CHF

2700K 3000K 4000K

58046 LED SET

9W
500mA



58046
1 × Einbaustrahler



1 × 500mA LED Modul
9W – 2700K, 3000K oder 4000K
Abstrahlwinkel 40° oder 60°



1 × 500mA | 6–12W
LED Konverter
Dimmbar [R, C]

58046 – LED Modul Set		
<input type="checkbox"/> weiss matt	93.00 CHF	<input type="checkbox"/> alu satin 98.00 CHF

2700K 3000K 4000K

58046 Dim to Warm LED SET

13W
310mA



58046
1 × Einbaustrahler



1 × 310mA **DTW** LED Modul
13W – 1800–3000K
Abstrahlwinkel 40° oder 60°



1 × 310mA
LED Konverter
Dimmbar [R, C]

58046 – Dim to Warm LED Modul Set		
<input type="checkbox"/> weiss matt	103.00 CHF	<input type="checkbox"/> alu satin 108.00 CHF

1800-3000K

58038 Einbaustrahler / 58038 - SET



Für Leuchtmittel Bauform	PAR16 und LED Retrofit ø50mm (bitte dazu bestellen)
Fassung	GU10 Fassung separat bestellen
Schutzart	IP 20
Schutzklasse	III
Material Gehäuse	Aluminium Druckguss
Dreh- und schwenkbar	355° / 30°
Einbau	Spreizfedern
Ausschnitt / Einbautiefe	AS ø80mm / ET 130
Massangaben	ø93mm

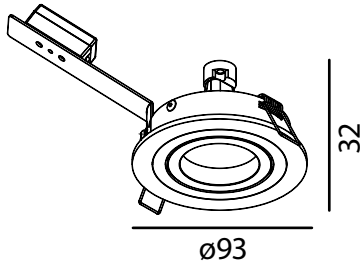

	Farbe	Einbau	
58038-00B	<input type="checkbox"/> weiss matt	Blattfeder	28.00 CHF
58038-00S	<input type="checkbox"/> weiss matt	Spreizfeder	28.00 CHF
58038-02B	<input type="checkbox"/> schwarz matt	Blattfeder	28.00 CHF
58038-02S	<input type="checkbox"/> schwarz matt	Spreizfeder	28.00 CHF
58038-16S	<input type="checkbox"/> alu satin	Spreizfeder	34.00 CHF

Zubehör

56001	GU10 Fassung ohne Klemmbügel sonderisoliert	6.50 CHF
56003	GU10 Fassung mit Klemmbügel sonderisoliert	8.00 CHF

Alle Preise excl. VRG, MwSt. und Leuchtmittel.

58038 GU10 LED SET

5W
230V AC



58038
1 × Einbaustrahler



1 × GU10 LEDspot
5W – 2700K oder 3000K
Abstrahlwinkel 38° | Dimmbar [R, C]



1 × GU10 HV-Fassung

58038 – 230V GU10 LED Set

<input type="checkbox"/> weiss matt	41.00 CHF	<input type="checkbox"/> alu satin	45.00 CHF
-------------------------------------	-----------	------------------------------------	-----------

2700K 3000K

58038 LED SET

6W
350mA



58038
1 × Einbaustrahler



1 × 350mA LED Modul
6W – 2700K, 3000K oder 4000K
Abstrahlwinkel 40° oder 60°



1 × 350mA | 4–9W
LED Converter
Dimmbar [R, C]

58038 – LED Modul Set

<input type="checkbox"/> weiss matt	90.00 CHF	<input type="checkbox"/> alu satin	95.00 CHF
-------------------------------------	-----------	------------------------------------	-----------

2700K 3000K 4000K

58038 LED SET

9W
500mA



58038
1 × Einbaustrahler



1 × 500mA LED Modul
9W – 2700K, 3000K oder 4000K
Abstrahlwinkel 40° oder 60°



1 × 500mA | 6–12W
LED Converter
Dimmbar [R, C]

58038 – LED Modul Set

<input type="checkbox"/> weiss matt	93.00 CHF	<input type="checkbox"/> alu satin	98.00 CHF
-------------------------------------	-----------	------------------------------------	-----------

2700K 3000K 4000K

58038 Dim to Warm LED SET

13W
310mA



58038
1 × Einbaustrahler



1 × 310mA DTW LED Modul
13W – 1800–3000K
Abstrahlwinkel 40° oder 60°



1 × 310mA
LED Converter
Dimmbar [R, C]

58038 – Dim to Warm LED Modul Set

<input type="checkbox"/> weiss matt	103.00 CHF	<input type="checkbox"/> alu satin	108.00 CHF
-------------------------------------	------------	------------------------------------	------------

1800-3000K

5838 Einbaustrahler / 5838 - SET



Für Leuchtmittel Bauform	PAR16 und LED Retrofit ø50mm (bitte dazu bestellen)
Fassung	GU10 Fassung separat bestellen
Schutzart	IP 20
Schutzklasse	III
Material Gehäuse	Aluminium gebürstet
Dreh- und schwenkbar	355 / 30°
Einbau	Blattfedern
Ausschnitt / Einbautiefe	AS ø80mm / ET 130
Massangaben	ø90mm

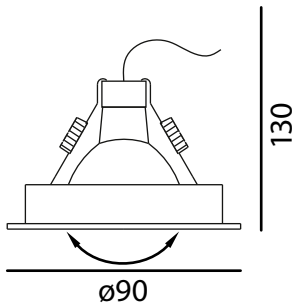

5838-16 alu satin **48.00 CHF**

Zubehör

56001	GU10 Fassung ohne Klemmbügel sonderisoliert	6.50 CHF
56003	GU10 Fassung mit Klemmbügel sonderisoliert	8.00 CHF

Alle Preise excl. VRG, MwSt. und Leuchtmittel.

5838 GU10 LED SET

5W
230V AC



5838
1 × Einbaustrahler



1 × GU10 LEDspot
5W – 2700K oder 3000K
Abstrahlwinkel 38° | Dimmbar [R, C]



1 × GU10 HV-Fassung

5838 – 230V GU10 LED Set

alu satin **62.00 CHF**

2700K **3000K**

5838 LED SET

6W
350mA



5838
1 × Einbaustrahler



1 × 350mA LED Modul
6W – 2700K, 3000K oder 4000K
Abstrahlwinkel 40° oder 60°



1 × 350mA | 4–9W
LED Konverter
Dimmbar [R, C]

5838 – LED Modul Set

alu satin **110.00 CHF**

2700K **3000K** **4000K**

5838 LED SET

9W
500mA



5838
1 × Einbaustrahler



1 × 500mA LED Modul
9W – 2700K, 3000K oder 4000K
Abstrahlwinkel 40° oder 60°



1 × 500mA | 6–12W
LED Konverter
Dimmbar [R, C]

5838 – LED Modul Set

alu satin **114.00 CHF**

2700K **3000K** **4000K**

5838 Dim to Warm LED SET

13W
310mA



5838
1 × Einbaustrahler



1 × 310mA **DTW** LED Modul
13W – 1800–3000K
Abstrahlwinkel 40° oder 60°



1 × 310mA
LED Konverter
Dimmbar [R, C]

5838 – Dim to Warm LED Modul Set

alu satin **124.00 CHF**

1800-3000K

5846 Einbaustrahler / 5846 - SET



Für Leuchtmittel Bauform	PAR16 und LED Retrofit ø50mm (bitte dazu bestellen)
Fassung	GU10 Fassung separat bestellen
Schutzart	IP 20
Schutzklasse	III
Material Gehäuse	Aluminium gebürstet
Dreh- und schwenkbar	355 / 30°
Einbau	Blattfedern
Ausschnitt / Einbautiefe	AS ø80mm / ET 130
Massangaben	90 × 90mm

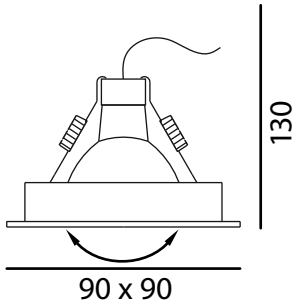

5846-16 ■ alu satin **48.00 CHF**

Zubehör

56001	GU10 Fassung ohne Klemmbügel sonderisoliert	6.50 CHF
56003	GU10 Fassung mit Klemmbügel sonderisoliert	8.00 CHF

Alle Preise excl. VRG, MwSt. und Leuchtmittel.

5846 GU10 LED SET

5W
230V AC



5846
1 × Einbaustrahler



1 × GU10 LEDspot
5W – 2700K oder 3000K
Abstrahlwinkel 38° | Dimmbar [R, C]



1 × GU10 HV-Fassung

5846 – 230V GU10 LED Set

■ alu satin **62.00 CHF**

2700K **3000K**

5846 LED SET

6W
350mA



5846
1 × Einbaustrahler



1 × 350mA LED Modul
6W – 2700K, 3000K oder 4000K
Abstrahlwinkel 40° oder 60°



1 × 350mA | 4–9W
LED Konverter
Dimmbar [R, C]

5846 – LED Modul Set

■ alu satin **110.00 CHF**

2700K **3000K** **4000K**

5846 LED SET

9W
500mA



5846
1 × Einbaustrahler



1 × 500mA LED Modul
9W – 2700K, 3000K oder 4000K
Abstrahlwinkel 40° oder 60°



1 × 500mA | 6–12W
LED Konverter
Dimmbar [R, C]

5846 – LED Modul Set

■ alu satin **114.00 CHF**

2700K **3000K** **4000K**

5846 Dim to Warm LED SET

13W
310mA



5846
1 × Einbaustrahler



1 × 310mA **DTW** LED Modul
13W – 1800–3000K
Abstrahlwinkel 40° oder 60°



1 × 310mA
LED Konverter
Dimmbar [R, C]

5846 – Dim to Warm LED Modul Set

■ alu satin **124.00 CHF**

1800-3000K

5846-SQ2 Einbaustrahler



Für Leuchtmittel Bauform	PAR16 und LED Retrofit ø50mm (bitte dazu bestellen)
Fassung	GU10 Fassung separat bestellen
Schutzart	IP 20
Schutzklasse	III
Material Gehäuse	Aluminium gebürstet
Dreh- und schwenkbar	355 / 30°
Einbau	Spreitzfedern
Ausschnitt / Einbautiefe	AS 80 × 162mm / ET 130
Massangaben	173 × 90mm

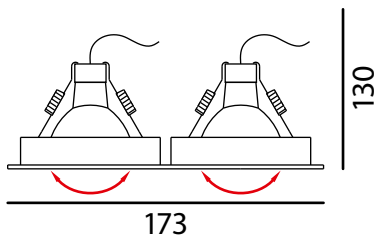

5846-SQ2 16 alu

98.00 CHF

Zubehör

56001	GU10 Fassung ohne Klemmbügel sonderisoliert	6.50 CHF
56003	GU10 Fassung mit Klemmbügel sonderisoliert	8.00 CHF
310400 162	Einbaugehäuse mit Tank AS 80 × 162mm	78.00 CHF

Alle Preise excl. VRG, MwSt. und Leuchtmittel.

5846-SQ3 Einbaustrahler



Für Leuchtmittel Bauform	PAR16 und LED Retrofit ø50mm (bitte dazu bestellen)
Fassung	GU10 Fassung separat bestellen
Schutzart	IP 20
Schutzklasse	III
Material Gehäuse	Aluminium gebürstet
Dreh- und schwenkbar	355 / 30°
Einbau	Spreitzfedern
Ausschnitt / Einbautiefe	AS 80 × 245mm / ET 130
Massangaben	255 × 90mm

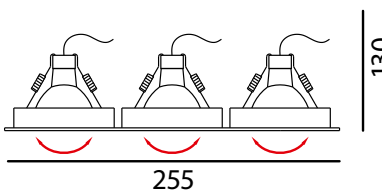

5846-SQ3 16 alu

Aluminium gebürstet Spreizfeder

148.00 CHF

Zubehör

56001	GU10 Fassung ohne Klemmbügel sonderisoliert	6.50 CHF
56003	GU10 Fassung mit Klemmbügel sonderisoliert	8.00 CHF
310400 245	Einbaugehäuse mit Tank AS 80 × 245mm	78.00 CHF

Alle Preise excl. VRG, MwSt. und Leuchtmittel.

5884 Einbaustrahler



Für Leuchtmittel Bauform	PAR16 und LED Retrofit ø50mm (bitte dazu bestellen)
Fassung	GU10 Fassung separat bestellen
Schutzart	IP 20
Schutzklasse	III
Material Gehäuse	Aluminium gebürstet
Einbau	Blattfedern
Ausschnitt / Einbautiefe	AS ø68–70mm / ET 130
Massangaben	ø80mm

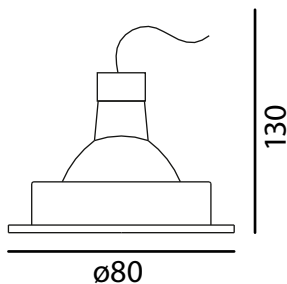

5884 zusammen mit **58001-AL**

5884-16	■ alu satin		34.00 CHF
58001-16	■ alu satin	Zusatzreflektor	11.50 CHF

Zubehör

56001	GU10 Fassung ohne Klemmbügel sonderisoliert	6.50 CHF
56003	GU10 Fassung mit Klemmbügel sonderisoliert	8.00 CHF

Alle Preise excl. VRG, MwSt. und Leuchtmittel.

5885 Einbaustrahler



Für Leuchtmittel Bauform	PAR16 und LED Retrofit ø50mm (bitte dazu bestellen)
Fassung	GU10 Fassung separat bestellen
Schutzart	IP 20
Schutzklasse	III
Material Gehäuse	Aluminium gebürstet
Einbau	Blattfedern
Ausschnitt / Einbautiefe	AS ø68–70mm / ET 130
Massangaben	80 × 80mm

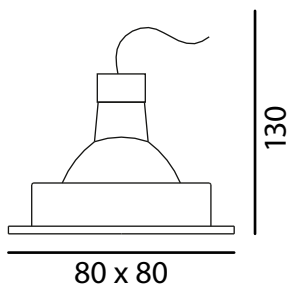

5884 zusammen mit **58001-AL**

5885-16	■ alu satin		38.00 CHF
58001-16	■ alu satin	Zusatzreflektor	11.50 CHF

Zubehör

56001	GU10 Fassung ohne Klemmbügel sonderisoliert	6.50 CHF
56003	GU10 Fassung mit Klemmbügel sonderisoliert	8.00 CHF
205070	Einbaugehäuse mit Tank AS ø70mm	52.00 CHF

Alle Preise excl. VRG, MwSt. und Leuchtmittel.

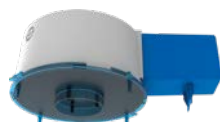

5681 Einbaustrahler / 5681 - SET



Für Leuchtmittel Bauform	PAR16 und LED Retrofit ø50mm (bitte dazu bestellen)
Fassung	GU10 Fassung separat bestellen
Schutzart	IP 20
Schutzklasse	III
Material Gehäuse	Aluminium Druckguss & Glas
Einbau	Blattfedern
Ausschnitt / Einbautiefe	AS ø68-70mm / ET 130
Massangaben	ø80 × 7mm

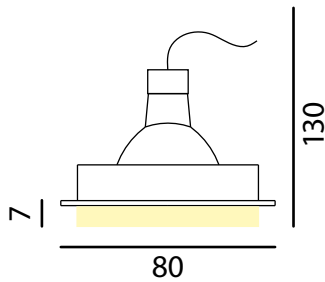

5681-01	<input type="checkbox"/> weiss	48.00 CHF
5681-04	<input type="checkbox"/> chrom	58.00 CHF
5681-05	<input type="checkbox"/> nickel satin	58.00 CHF
5681-09	<input type="checkbox"/> chrommatt	58.00 CHF

Zubehör

56001	GU10 Fassung ohne Klemmbügel sonderisoliert	6.50 CHF
56003	GU10 Fassung mit Klemmbügel sonderisoliert	8.00 CHF

Alle Preise excl. VRG, MwSt. und Leuchtmittel.

5681 GU10 LED SET

5W
230V AC



5681
1 × Einbaustrahler



1 × GU10 LEDspot
5W – 2700K oder 3000K
Abstrahlwinkel 38° | Dimmbar [R, C]



1 × GU10 HV-Fassung

5681 – 230V GU10 LED Set

<input type="checkbox"/> weiss	61.00 CHF	<input type="checkbox"/> nickel satin	69.00 CHF
<input type="checkbox"/> chrom	69.00 CHF	<input type="checkbox"/> chrommatt	69.00 CHF

2700K **3000K**

5681 LED SET

6W
350mA



5681
1 × Einbaustrahler



1 × 350mA LED Modul
6W – 2700K, 3000K oder 4000K
Abstrahlwinkel 40° oder 60°



1 × 350mA | 4–9W
LED Konverter
Dimmbar [R, C]

5681 – LED Modul Set

<input type="checkbox"/> weiss	110.00 CHF	<input type="checkbox"/> nickel satin	119.00 CHF
<input type="checkbox"/> chrom	119.00 CHF	<input type="checkbox"/> chrommatt	119.00 CHF

2700K **3000K** **4000K**

5681 LED SET

9W
500mA



5681
1 × Einbaustrahler



1 × 500mA LED Modul
9W – 2700K, 3000K oder 4000K
Abstrahlwinkel 40° oder 60°



1 × 500mA | 6–12W
LED Konverter
Dimmbar [R, C]

5681 – LED Modul Set

<input type="checkbox"/> weiss	113.00 CHF	<input type="checkbox"/> nickel satin	122.00 CHF
<input type="checkbox"/> chrom	122.00 CHF	<input type="checkbox"/> chrommatt	122.00 CHF

2700K **3000K** **4000K**

5681 Dim to Warm LED SET

13W
310mA



5681
1 × Einbaustrahler



1 × 310mA **DTW** LED Modul
13W – 1800–3000K
Abstrahlwinkel 40° oder 60°



1 × 310mA
LED Konverter
Dimmbar [R, C]

5681 – Dim to Warm LED Modul Set

<input type="checkbox"/> weiss	123.00 CHF	<input type="checkbox"/> nickel satin	132.00 CHF
<input type="checkbox"/> chrom	132.00 CHF	<input type="checkbox"/> chrommatt	132.00 CHF

1800-3000K

5680 Einbaustrahler / 5680 - SET



Für Leuchtmittel Bauform	PAR16 und LED Retrofit ø50mm (bitte dazu bestellen)
Fassung	GU10 Fassung separat bestellen
Schutzart	IP 20
Schutzklasse	III
Material Gehäuse	Aluminium Druckguss & Glas
Einbau	Blattfedern
Ausschnitt / Einbautiefe	AS ø68–70mm / ET 130
Massangaben	ø80 × 25mm

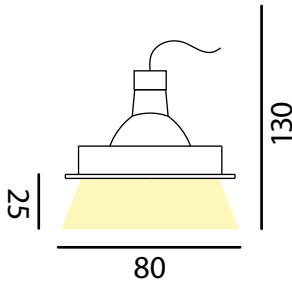

5680-01	<input type="checkbox"/> weiss	48.00 CHF
5680-04	<input type="checkbox"/> chrom	58.00 CHF
5680-05	<input type="checkbox"/> nickel satin	58.00 CHF
5680-09	<input type="checkbox"/> chrommatt	58.00 CHF

Zubehör

56001	GU10 Fassung ohne Klemmbügel sonderisoliert	6.50 CHF
56003	GU10 Fassung mit Klemmbügel sonderisoliert	8.00 CHF

Alle Preise excl. VRG, MwSt. und Leuchtmittel.

5680 GU10 LED SET

5W
230V AC



5680
1 × Einbaustrahler



1 × GU10 LEDspot
5W – 2700K oder 3000K
Abstrahlwinkel 38° | Dimmbar [R, C]



1 × GU10 HV-Fassung

5680 – 230V GU10 LED Set

<input type="checkbox"/> weiss	61.00 CHF	<input type="checkbox"/> nickel satin	69.00 CHF
<input type="checkbox"/> chrom	69.00 CHF	<input type="checkbox"/> chrommatt	69.00 CHF

2700K 3000K

5680 LED SET

6W
350mA



5680
1 × Einbaustrahler



1 × 350mA LED Modul
6W – 2700K, 3000K oder 4000K
Abstrahlwinkel 40° oder 60°



1 × 350mA | 4–9W
LED Converter
Dimmbar [R, C]

5680 – LED Modul Set

<input type="checkbox"/> weiss	110.00 CHF	<input type="checkbox"/> nickel satin	119.00 CHF
<input type="checkbox"/> chrom	119.00 CHF	<input type="checkbox"/> chrommatt	119.00 CHF

2700K 3000K 4000K

5680 LED SET

9W
500mA



5680
1 × Einbaustrahler



1 × 500mA LED Modul
9W – 2700K, 3000K oder 4000K
Abstrahlwinkel 40° oder 60°



1 × 500mA | 6–12W
LED Converter
Dimmbar [R, C]

5680 – LED Modul Set

<input type="checkbox"/> weiss	113.00 CHF	<input type="checkbox"/> nickel satin	122.00 CHF
<input type="checkbox"/> chrom	122.00 CHF	<input type="checkbox"/> chrommatt	122.00 CHF

2700K 3000K 4000K

5680 Dim to Warm LED SET

13W
310mA



5680
1 × Einbaustrahler



1 × 310mA DTW LED Modul
13W – 1800–3000K
Abstrahlwinkel 40° oder 60°



1 × 310mA
LED Converter
Dimmbar [R, C]

5680 – Dim to Warm LED Modul Set

<input type="checkbox"/> weiss	123.00 CHF	<input type="checkbox"/> nickel satin	132.00 CHF
<input type="checkbox"/> chrom	132.00 CHF	<input type="checkbox"/> chrommatt	132.00 CHF

1800-3000K

5682 Einbaustrahler / 5682 - SET



Für Leuchtmittel Bauform	PAR16 und LED Retrofit ø50mm (bitte dazu bestellen)
Fassung	GU10 Fassung separat bestellen
Schutzart	IP 20
Schutzklasse	III
Material Gehäuse	Aluminium Druckguss & Glas
Einbau	Blattfedern
Ausschnitt / Einbautiefe	AS ø68-70mm / ET 130
Massangaben	ø80 × 28mm

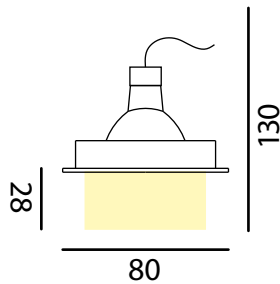

5682-01	<input type="checkbox"/> weiss	48.00 CHF
5682-04	<input type="checkbox"/> chrom	58.00 CHF
5682-05	<input type="checkbox"/> nickel satin	58.00 CHF
5682-09	<input type="checkbox"/> chrommatt	58.00 CHF

Zubehör

56001	GU10 Fassung ohne Klemmbügel sonderisoliert	6.50 CHF
56003	GU10 Fassung mit Klemmbügel sonderisoliert	8.00 CHF

Alle Preise excl. VRG, MwSt. und Leuchtmittel.

5682 GU10 LED SET

5W
230V AC



5682
1 × Einbaustrahler



1 × GU10 LEDspot
5W – 2700K oder 3000K
Abstrahlwinkel 38° | Dimmbar [R, C]



1 × GU10 HV-Fassung

5682 – 230V GU10 LED Set

<input type="checkbox"/> weiss	61.00 CHF	<input type="checkbox"/> nickel satin	69.00 CHF
<input type="checkbox"/> chrom	69.00 CHF	<input type="checkbox"/> chrommatt	69.00 CHF

2700K **3000K**

5682 LED SET

6W
350mA



5682
1 × Einbaustrahler



1 × 350mA LED Modul
6W – 2700K, 3000K oder 4000K
Abstrahlwinkel 40° oder 60°



1 × 350mA | 4–9W
LED Konverter
Dimmbar [R, C]

5682 – LED Modul Set

<input type="checkbox"/> weiss	110.00 CHF	<input type="checkbox"/> nickel satin	119.00 CHF
<input type="checkbox"/> chrom	119.00 CHF	<input type="checkbox"/> chrommatt	119.00 CHF

2700K **3000K** **4000K**

5682 LED SET

9W
500mA



5682
1 × Einbaustrahler



1 × 500mA LED Modul
9W – 2700K, 3000K oder 4000K
Abstrahlwinkel 40° oder 60°



1 × 500mA | 6–12W
LED Konverter
Dimmbar [R, C]

5682 – LED Modul Set

<input type="checkbox"/> weiss	113.00 CHF	<input type="checkbox"/> nickel satin	122.00 CHF
<input type="checkbox"/> chrom	122.00 CHF	<input type="checkbox"/> chrommatt	122.00 CHF

2700K **3000K** **4000K**

5682 Dim to Warm LED SET

13W
310mA



5682
1 × Einbaustrahler



1 × 310mA **DTW** LED Modul
13W – 1800–3000K
Abstrahlwinkel 40° oder 60°



1 × 310mA
LED Konverter
Dimmbar [R, C]

5682 – Dim to Warm LED Modul Set

<input type="checkbox"/> weiss	123.00 CHF	<input type="checkbox"/> nickel satin	132.00 CHF
<input type="checkbox"/> chrom	132.00 CHF	<input type="checkbox"/> chrommatt	132.00 CHF

1800-3000K

5643MD Einbaustrahler IP44



Für Leuchtmittel Bauform	PAR16 und LED Retrofit ø50mm (bitte dazu bestellen)
Fassung	GU10 Fassung separat bestellen
Schutzart	IP 44
Schutzklasse	III
Material Gehäuse	Aluminium Druckguss / Kunststoff
Einbau	Blattfeder
Ausschnitt / Einbautiefe	AS ø80mm / ET 100
Massangaben	ø90mm

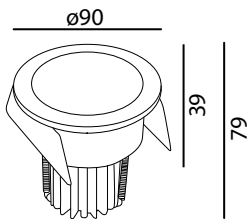

5643MD-00	<input type="checkbox"/> weiss matt	52.00 CHF
5643MD-01	<input type="checkbox"/> weiss	52.00 CHF
5643MD-04	<input type="checkbox"/> chrom	58.00 CHF
5643MD-05	<input type="checkbox"/> nickel satin	58.00 CHF
5643MD-09	<input type="checkbox"/> chrommatt	58.00 CHF
5643MD-11	<input type="checkbox"/> alu satin	58.00 CHF

Zubehör

56001	GU10 Fassung ohne Klemmbügel sonderisoliert	6.50 CHF
56003	GU10 Fassung mit Klemmbügel sonderisoliert	8.00 CHF

Alle Preise excl. VRG, MwSt. und Leuchtmittel.

5643MD

GU10 LED SET

5W

230V AC



5643MD
1 × Einbaustrahler



1 × GU10 LEDspot
5W – 2700K oder 3000K
Abstrahlwinkel 38° | Dimmbar [R, C]



1 × GU10 HV-Fassung

5643MD – 230V GU10 LED Set

<input type="checkbox"/> weiss matt	65.00 CHF	<input type="checkbox"/> nickel satin	69.00 CHF
<input type="checkbox"/> weiss	65.00 CHF	<input type="checkbox"/> chrommatt	69.00 CHF
<input type="checkbox"/> chrom	69.00 CHF	<input type="checkbox"/> alu satin	69.00 CHF

2700K

3000K

5643MD

LED SET

6W

350mA



5643MD
1 × Einbaustrahler



1 × 350mA LED Modul
6W – 2700K, 3000K oder 4000K
Abstrahlwinkel 40° oder 60°



1 × 350mA | 4–9W
LED Converter
Dimmbar [R, C]

5643MD – LED Modul Set

<input type="checkbox"/> weiss matt	114.00 CHF	<input type="checkbox"/> nickel satin	119.00 CHF
<input type="checkbox"/> weiss	114.00 CHF	<input type="checkbox"/> chrommatt	119.00 CHF
<input type="checkbox"/> chrom	119.00 CHF	<input type="checkbox"/> alu satin	119.00 CHF

2700K

3000K

4000K

5643MD

LED SET

9W

500mA



5643MD
1 × Einbaustrahler



1 × 500mA LED Modul
9W – 2700K, 3000K oder 4000K
Abstrahlwinkel 40° oder 60°



1 × 500mA | 6–12W
LED Converter
Dimmbar [R, C]

5643MD – LED Modul Set

<input type="checkbox"/> weiss matt	117.00 CHF	<input type="checkbox"/> nickel satin	122.00 CHF
<input type="checkbox"/> weiss	117.00 CHF	<input type="checkbox"/> chrommatt	122.00 CHF
<input type="checkbox"/> chrom	122.00 CHF	<input type="checkbox"/> alu satin	122.00 CHF

2700K

3000K

4000K

5643MD

Dim to Warm LED SET

13W

310mA



5643MD
1 × Einbaustrahler



1 × 310mA DTW LED Modul
13W – 1800–3000K
Abstrahlwinkel 40° oder 60°



1 × 310mA
LED Converter
Dimmbar [R, C]

5643MD – Dim to Warm LED Modul Set

<input type="checkbox"/> weiss matt	127.00 CHF	<input type="checkbox"/> nickel satin	132.00 CHF
<input type="checkbox"/> weiss	127.00 CHF	<input type="checkbox"/> chrommatt	132.00 CHF
<input type="checkbox"/> chrom	132.00 CHF	<input type="checkbox"/> alu satin	132.00 CHF

1800-3000K

5644MD Einbaustrahler IP44



Für Leuchtmittel Bauform	PAR16 und LED Retrofit ø50mm (bitte dazu bestellen)
Fassung	GU10 Fassung separat bestellen
Schutzart	IP 44
Schutzklasse	III
Material Gehäuse	Aluminium Druckguss / Kunststoff
Einbau	Blattfeder
Ausschnitt / Einbautiefe	AS ø80mm / ET 100
Massangaben	90 × 90mm

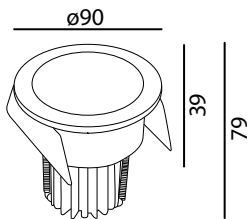

5644MD-00	<input type="checkbox"/> weiss matt	52.00 CHF
5644MD-01	<input type="checkbox"/> weiss	52.00 CHF
5644MD-04	<input type="checkbox"/> chrom	58.00 CHF
5644MD-05	<input type="checkbox"/> nickel satin	58.00 CHF
5644MD-09	<input type="checkbox"/> chrommatt	58.00 CHF
5644MD-11	<input type="checkbox"/> alu satin	58.00 CHF

Zubehör

56001	GU10 Fassung ohne Klemmbügel sonderisoliert	6.50 CHF
56003	GU10 Fassung mit Klemmbügel sonderisoliert	8.00 CHF

Alle Preise excl. VRG, MwSt. und Leuchtmittel.

5644MD

GU10 LED SET

5W
230V AC



5644MD
1 × Einbaustrahler



1 × GU10 LEDspot
5W – 2700K oder 3000K
Abstrahlwinkel 38° | Dimmbar [R, C]



1 × GU10 HV-Fassung

5644MD – 230V GU10 LED Set

<input type="checkbox"/> weiss matt	65.00 CHF	<input type="checkbox"/> nickel satin	69.00 CHF
<input type="checkbox"/> weiss	65.00 CHF	<input type="checkbox"/> chrommatt	69.00 CHF
<input type="checkbox"/> chrom	69.00 CHF	<input type="checkbox"/> alu satin	69.00 CHF

2700K **3000K**

5644MD

LED SET

6W
350mA



5644MD
1 × Einbaustrahler



1 × 350mA LED Modul
6W – 2700K, 3000K oder 4000K
Abstrahlwinkel 40° oder 60°



1 × 350mA | 4–9W
LED Konverter
Dimmbar [R, C]

5644MD – LED Modul Set

<input type="checkbox"/> weiss matt	114.00 CHF	<input type="checkbox"/> nickel satin	119.00 CHF
<input type="checkbox"/> weiss	114.00 CHF	<input type="checkbox"/> chrommatt	119.00 CHF
<input type="checkbox"/> chrom	119.00 CHF	<input type="checkbox"/> alu satin	119.00 CHF

2700K **3000K** **4000K**

5644MD

LED SET

9W
500mA



5644MD
1 × Einbaustrahler



1 × 500mA LED Modul
9W – 2700K, 3000K oder 4000K
Abstrahlwinkel 40° oder 60°



1 × 500mA | 6–12W
LED Konverter
Dimmbar [R, C]

5644MD – LED Modul Set

<input type="checkbox"/> weiss matt	117.00 CHF	<input type="checkbox"/> nickel satin	122.00 CHF
<input type="checkbox"/> weiss	117.00 CHF	<input type="checkbox"/> chrommatt	122.00 CHF
<input type="checkbox"/> chrom	122.00 CHF	<input type="checkbox"/> alu satin	122.00 CHF

2700K **3000K** **4000K**

5644MD

Dim to Warm LED SET

13W
310mA



5644MD
1 × Einbaustrahler



1 × 310mA **DTW** LED Modul
13W – 1800–3000K
Abstrahlwinkel 40° oder 60°



1 × 310mA
LED Konverter
Dimmbar [R, C]

5644MD – Dim to Warm LED Modul Set

<input type="checkbox"/> weiss matt	127.00 CHF	<input type="checkbox"/> nickel satin	132.00 CHF
<input type="checkbox"/> weiss	127.00 CHF	<input type="checkbox"/> chrommatt	132.00 CHF
<input type="checkbox"/> chrom	132.00 CHF	<input type="checkbox"/> alu satin	132.00 CHF

1800-3000K

5641 Einbaustrahler



Für Leuchtmittel Bauform	ausschliesslich PAR16 (bitte dazu bestellen)
Fassung	GU10 fest integriert
Schutzart	IP 20
Schutzklasse	III
Material Gehäuse	Stahl
Einbau	Blattfedern
Ausschnitt / Einbautiefe	AS 68-70mm / ET 130
Massangaben	ø86 × 93mm

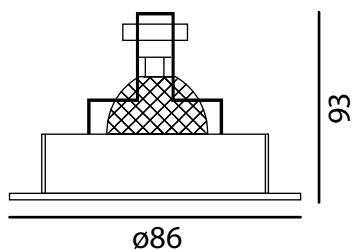

5641-01	<input type="checkbox"/> weiss	24.00 CHF
5641-04	<input type="checkbox"/> chrom	28.00 CHF
5641-05	<input type="checkbox"/> nickel satin	28.00 CHF
5641-09	<input type="checkbox"/> chrommatt	28.00 CHF



Zubehör		
5641-ER	Ring für randlosen Deckeneinbau	9.00 CHF
205070	Einbaugehäuse mit Tank AS ø70mm	52.00 CHF
205075	Einbaugehäuse mit Tank AS ø75mm für randlos	52.00 CHF

Alle Preise excl. VRG, MwSt. und Leuchtmittel.

5642 Einbaustrahler



Für Leuchtmittel Bauform	ausschliesslich PAR16 (bitte dazu bestellen)
Fassung	GU10 fest integriert
Schutzart	IP 20
Schutzklasse	III
Material Gehäuse	Stahl
Schwenkbar	20°
Einbau	Blattfedern
Ausschnitt / Einbautiefe	AS 68-70mm / ET 130
Massangaben	ø85mm

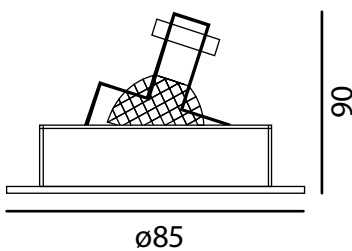

5642-01	<input type="checkbox"/> weiss	28.00 CHF
5642-04	<input type="checkbox"/> chrom	32.00 CHF
5642-05	<input type="checkbox"/> nickel satin	32.00 CHF
5642-09	<input type="checkbox"/> chrommatt	32.00 CHF



Zubehör		
5641/42-ER	Ring für randlosen Deckeneinbau	9.00 CHF
205070	Einbaugehäuse mit Tank AS ø70mm	52.00 CHF
205075	Einbaugehäuse mit Tank AS ø75mm für randlos	52.00 CHF

Alle Preise excl. VRG, MwSt. und Leuchtmittel.

5624 Einbaustrahler für Metalldecken



Für Leuchtmittel Bauform	PAR16 und LED Retrofit ø50mm (bitte dazu bestellen)
Fassung	GU10 Fassung separat bestellen
Schutzart	IP 20
Schutzklasse	III
Material Gehäuse	Stahl
Schwenkbar	40°
Einbau	Rollfedern
Ausschnitt / Einbautiefe	AS ø60mm / ET 130
Massangaben	ø76mm

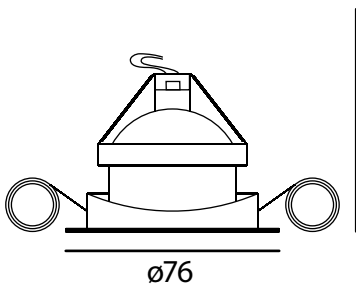

5624-01	<input type="checkbox"/> weiss	48.00 CHF
5624-04	<input type="checkbox"/> chrom	56.00 CHF
5624-05	<input type="checkbox"/> nickel satin	56.00 CHF
5624-09	<input type="checkbox"/> chrommatt	56.00 CHF

Zubehör

56001	GU10 Fassung ohne Klemmbügel sonderisoliert	6.50 CHF
56003	GU10 Fassung mit Klemmbügel sonderisoliert	8.00 CHF

Alle Preise excl. VRG, MwSt. und Leuchtmittel.

5690 Einbaustrahler



Für Leuchtmittel Bauform	PAR16 und LED Retrofit ø50mm (bitte dazu bestellen)
Fassung	GU10 Fassung separat bestellen
Schutzart	IP 20
Schutzklasse	III
Material Gehäuse	Aluminium Druckguss
Schwenkbar	20°
Einbau	Blattfedern
Ausschnitt / Einbautiefe	AS ø82mm / ET 130
Massangaben	ø92mm

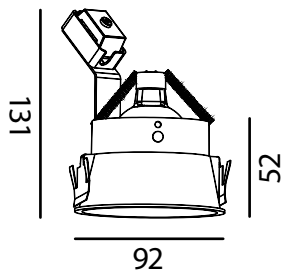

5690-01	<input type="checkbox"/> weiss	58.00 CHF
---------	--------------------------------	-----------

Zubehör

56001	GU10 Fassung ohne Klemmbügel sonderisoliert	6.50 CHF
56003	GU10 Fassung mit Klemmbügel sonderisoliert	8.00 CHF

Alle Preise excl. VRG, MwSt. und Leuchtmittel.

5640 Einbaustrahler

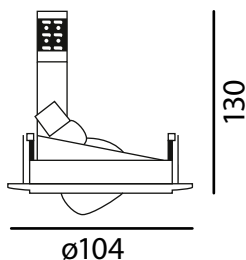

Für Leuchtmittel Bauform	ausschliesslich PAR16 (bitte dazu bestellen)
Fassung	GU10 Fassung separat bestellen
Schutzart	IP 20
Schutzklasse	III
Material Gehäuse	Aluminium Druckguss
Dreh- und schwenkbar	355° / 40°
Einbau	Blattfedern
Ausschnitt / Einbautiefe	AS ø90mm / ET 130
Massangaben	ø104mm

5640-01	weiss	44.00 CHF
5640-03	gold	54.00 CHF
5640-04	chrom	54.00 CHF
5640-05	nickel satin	54.00 CHF
5640-09	chrommatt	54.00 CHF
5640-11	alu satin	54.00 CHF

Zubehör		
56001	GU10 Fassung ohne Klemmbügel sonderisoliert	6.50 CHF
56003	GU10 Fassung mit Klemmbügel sonderisoliert	8.00 CHF

Alle Preise excl. VRG, MwSt. und Leuchtmittel.

5636 Einbaustrahler

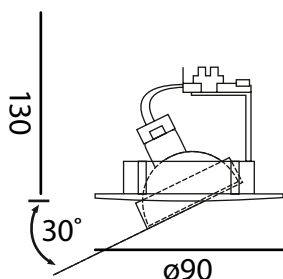

Für Leuchtmittel Bauform	PAR16 und LED Retrofit ø50mm (bitte dazu bestellen)
Fassung	GU10 Fassung separat bestellen
Schutzart	IP 20
Schutzklasse	III
Material Gehäuse	Aluminium Druckguss
Dreh- und schwenkbar	355 / 30°
Einbau	Blattfedern
Ausschnitt / Einbautiefe	AS ø80mm / ET 130
Massangaben	ø90mm

5636-01	weiss	32.00 CHF
5636-03	gold	40.00 CHF
5636-04	chrom	40.00 CHF
5636-05	nickel satin	40.00 CHF
5636-09	chrommatt	40.00 CHF
5636-11	alu satin	40.00 CHF

Zubehör		
56001	GU10 Fassung ohne Klemmbügel sonderisoliert	6.50 CHF
56003	GU10 Fassung mit Klemmbügel sonderisoliert	8.00 CHF

Alle Preise excl. VRG, MwSt. und Leuchtmittel.

5438 Einbaustrahler



Für Leuchtmittel Bauform	ausschliesslich PAR16 (bitte dazu bestellen)
Fassung	GU10 Fassung separat bestellen
Schutzart	IP 20
Schutzklasse	III
Material Gehäuse	Aluminium Druckguss
Dreh- und schwenkbar	355° / 45°
Einbau	Blattfedern
Ausschnitt / Einbautiefe	AS ø85mm / ET 130
Massangaben	ø100mm

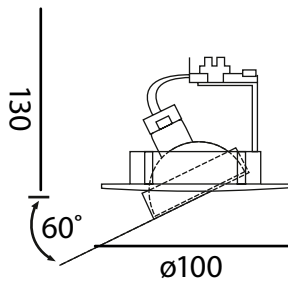

5438-01	weiss	42.00 CHF
5438-04	chrom	52.00 CHF
5438-05	nickel satin	52.00 CHF
5438-75	silber	42.00 CHF

Zubehör

56001	GU10 Fassung ohne Klemmbügel sonderisoliert	6.50 CHF
56003	GU10 Fassung mit Klemmbügel sonderisoliert	8.00 CHF

Alle Preise excl. VRG, MwSt. und Leuchtmittel.

5446 Einbaustrahler



Für Leuchtmittel Bauform	ausschliesslich PAR16 (bitte dazu bestellen)
Fassung	GU10 Fassung separat bestellen
Schutzart	IP 20
Schutzklasse	III
Material Gehäuse	Aluminium Druckguss
Dreh- und schwenkbar	355° / 45°
Einbau	Blattfedern
Ausschnitt / Einbautiefe	AS ø85mm / ET 130
Massangaben	100 × 100mm

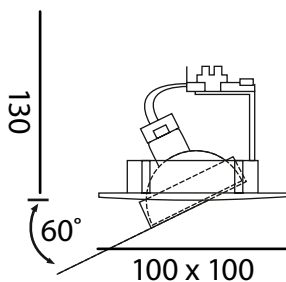

5446-01	weiss	46.00 CHF
5446-04	chrom	56.00 CHF
5446-05	nickel satin	56.00 CHF
5446-75	silberfarbig	46.00 CHF

Zubehör

56001	GU10 Fassung ohne Klemmbügel sonderisoliert	6.50 CHF
56003	GU10 Fassung mit Klemmbügel sonderisoliert	8.00 CHF

Alle Preise excl. VRG, MwSt. und Leuchtmittel.



59010 Einbaustrahler



Für Leuchtmittel Bauform **PAR16 und LED Retrofit ø50mm**
(bitte dazu bestellen)

Fassung Inkl. GU10 Fassung

Schutzart IP 20

Schutzklasse III

Material Gehäuse Aluminium Druckguss

Dreh- und schwenkbar 355° / 18°

Einbau Montage Rahmen

Ausschnitt / Einbautiefe AS ø114mm / ET 140

Massangaben ø85mm

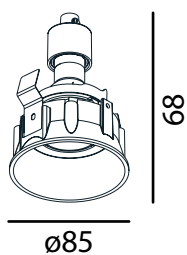
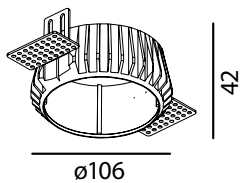

59010-00 weiss matt

82.00 CHF

Zubehör

56001 GU10 Fassung **ohne** Klemmbügel sonderisoliert

6.50 CHF

59010-EB Einbaugehäuse

98.00 CHF

Alle Preise excl. VRG, MwSt. und Leuchtmittel.



59015 Einbaustrahler



Für Leuchtmittel Bauform	PAR16 und LED Retrofit ø50mm (bitte dazu bestellen)
Fassung	Inkl. GU10 Fassung
Schutzart	IP 20
Schutzklasse	III
Material Gehäuse	Aluminium Druckguss
Dreh- und schwenkbar	18°
Einbau	Montage Rahmen
Ausschnitt / Einbautiefe	AS 110 × 110mm / ET 140
Massangaben	92 × 92mm

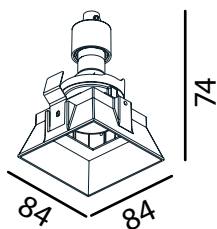
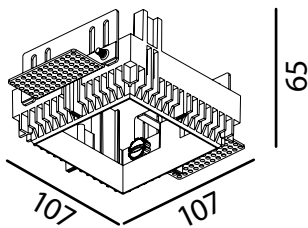

59015-00 weiss matt

92.00 CHF

Zubehör

56001	GU10 Fassung ohne Klemmbügel sonderisoliert	6.50 CHF
59015-EB	Einbaugehäuse	98.00 CHF

Alle Preise excl. VRG, MwSt. und Leuchtmittel.



PLENUM

PLENUM

MASS

DEVOL

DEVOL

DEVOL

DEVOL

DEVOL

DEVOL

DEVOL

DEVOL

DEVOL

DEVOL

DEVOL

ESABIN
CHAMPAGNE
EXTRA DRY

DEVOL

DEVOL

DEVOL

DEVOL

DEVOL

DEVOL

DEVOL

5649 Einbaustrahler



Für Leuchtmittel Bauform	ausschliesslich PAR16 (bitte dazu bestellen)
Fassung	GU10 Fassung separat bestellen
Schutzart	IP 20
Schutzklasse	III
Material Gehäuse	Aluminium / Edelstahl
Schwenkbar	20°
Einbau	Spreitzfedern
Ausschnitt / Einbautiefe	AS ø80mm / ET 130
Massangaben	90 × 90mm

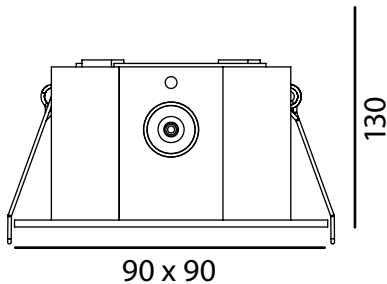

5649-01	weiss-schwarz	50.00 CHF
5649-10	inox-schwarz	78.00 CHF
5649-75	silber-schwarz	50.00 CHF

Zubehör

56001	GU10 Fassung ohne Klemmbügel sonderisoliert	6.50 CHF
56003	GU10 Fassung mit Klemmbügel sonderisoliert	8.00 CHF

Alle Preise excl. VRG, MwSt. und Leuchtmittel.

5648 Einbaustrahler



Für Leuchtmittel Bauform	ausschliesslich PAR16 (bitte dazu bestellen)
Fassung	GU10 Fassung separat bestellen
Schutzart	IP 20
Schutzklasse	III
Material Gehäuse	Stahl
Schwenkbar	30°
Einbau	Spreitzfedern
Ausschnitt / Einbautiefe	AS 73 × 73mm / ET 130
Massangaben	85 × 85mm

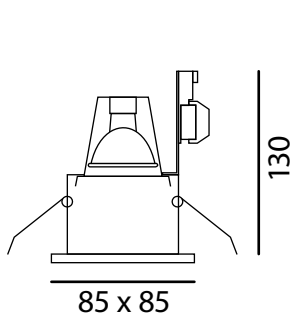

5648-01	weiss	48.00 CHF
5648-05	nickel satin	50.00 CHF
5648-14	silber-schwarz	50.00 CHF
5648-75	silber	48.00 CHF

Zubehör

56001	GU10 Fassung ohne Klemmbügel sonderisoliert	6.50 CHF
56003	GU10 Fassung mit Klemmbügel sonderisoliert	8.00 CHF

Alle Preise excl. VRG, MwSt. und Leuchtmittel.

56048 Einbaustrahler



Für Leuchtmittel Bauform	ausschliesslich PAR16 (bitte dazu bestellen)
Fassung	GU10 Fassung separat bestellen
Schutzart	IP 20
Schutzklasse	III
Material Gehäuse	Aluminium
Kardanisch	20° / 20°
Einbau	Spreitzfedern
Ausschnitt / Einbautiefe	AS 83 × 83mm / ET 130
Massangaben	92 × 92mm

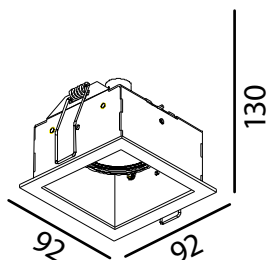

56048-00 weiss matt 44.00 CHF

Zubehör		
56001	GU10 Fassung ohne Klemmbügel sonderisoliert	6.50 CHF
56003	GU10 Fassung mit Klemmbügel sonderisoliert	8.00 CHF

Alle Preise excl. VRG, MwSt. und Leuchtmittel.

5654 Einbaustrahler



Für Leuchtmittel Bauform	ausschliesslich PAR16 (bitte dazu bestellen)
Fassung	GU10 Fassung separat bestellen
Schutzart	IP 20
Schutzklasse	III
Material Gehäuse	Stahl mit Glas mattiert
Schwenkbar	30°
Einbau	Spreitzfedern
Ausschnitt / Einbautiefe	AS 73 × 73mm / ET 130
Massangaben	85 × 85mm

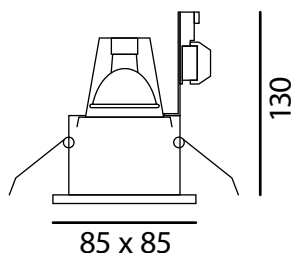

5654-01 weiss 64.00 CHF
 5654-05 nickel satin 68.00 CHF
 5654-75 silber 64.00 CHF

Zubehör		
56001	GU10 Fassung ohne Klemmbügel sonderisoliert	6.50 CHF
56003	GU10 Fassung mit Klemmbügel sonderisoliert	8.00 CHF

Alle Preise excl. VRG, MwSt. und Leuchtmittel.



5444 / 5454 Einbaustrahler IP44



Für Leuchtmittel Bauform	ausschliesslich PAR16 (bitte dazu bestellen)
Fassung	GU5.3 und G10 integriert
Schutzart	IP 44
Schutzklasse	III
Material Gehäuse	Aluminium Druckguss
Dreh- und schwenkbar	— / 20°
Einbau	Spreitzfeder
Ausschnitt / Einbautiefe	AS 76 × 76mm / ET 130
Massangaben	90 × 90mm

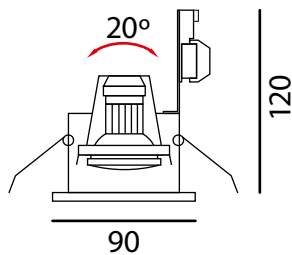

12V AC GU5.3	230V AC GU10
5444-01	5454-01
5444-75	5454-75

<input type="checkbox"/> weiss	58.00 CHF
<input type="checkbox"/> silberfarbig	58.00 CHF

Alle Preise excl. VRG, MwSt. und Leuchtmittel.

5910 Einbaustrahler



Für Leuchtmittel Bauform	ausschliesslich PAR16 (bitte dazu bestellen)
Fassung	GU10 Fassung separat bestellen
Schutzart	IP 20
Schutzklasse	III
Material Gehäuse	Aluminium / Stahl
Kardanisch	30° / 30°
Einbau	Spreitzfedern
Ausschnitt / Einbautiefe	AS 96 × 96mm / ET 130
Massangaben	110 × 110mm

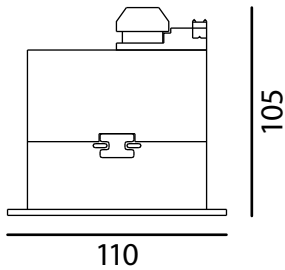
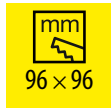

5910-12	weiss-schwarz	68.00 CHF
5910-75	silberfarbig	68.00 CHF

Zubehör

56001	GU10 Fassung ohne Klemmbügel sonderisoliert	6.50 CHF
200400 95	Einbaugehäuse AS 96 × 96mm	34.00 CHF

Alle Preise excl. VRG, MwSt. und Leuchtmittel.

5912 Einbaustrahler



Für Leuchtmittel Bauform	ausschliesslich PAR16 (bitte dazu bestellen)
Fassung	GU10 Fassung separat bestellen
Schutzart	IP 20
Schutzklasse	III
Material Gehäuse	Aluminium / Stahl
Kardanisch	30° / 30°
Einbau	Spreitzfedern
F-Ausschnitt / Einbautiefe	AS 96 × 190mm / ET 130
Massangaben	110 × 201mm

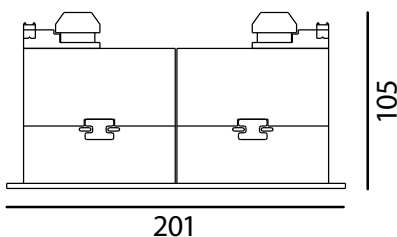

5912-12	weiss-schwarz	98.00 CHF
5912-75	silberfarbig	98.00 CHF

Zubehör

56001	GU10 Fassung ohne Klemmbügel sonderisoliert	6.50 CHF
400500 190	Einbaugehäuse AS 96 × 190mm	93.00 CHF

Alle Preise excl. VRG, MwSt. und Leuchtmittel.

5913 Einbaustrahler



Für Leuchtmittel Bauform	ausschliesslich PAR16 (bitte dazu bestellen)
Fassung	GU10 Fassung separat bestellen
Schutzart	IP 20
Schutzklasse	III
Material Gehäuse	Aluminium / Stahl
Kardanisch	30° / 30°
Einbau	Spreitzfedern
Ausschnitt / Einbautiefe	AS 96 × 274mm / ET 130
Massangaben	110 × 292mm

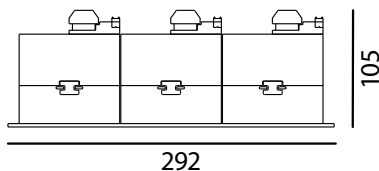

5913-75 **silber** **124.00 CHF**

Zubehör

56001	GU10 Fassung ohne Klemmbügel sonderisoliert	6.50 CHF
400500 274	Einbaugehäuse AS 96 × 274mm	93.00 CHF

Alle Preise excl. VRG, MwSt. und Leuchtmittel.

5914 Einbaustrahler



Für Leuchtmittel Bauform	ausschliesslich PAR16 (bitte dazu bestellen)
Fassung	GU10 Fassung separat bestellen
Schutzart	IP 20
Schutzklasse	III
Material Gehäuse	Aluminium / Stahl
Kardanisch	30° / 30°
Einbau	Spreitzfedern
Ausschnitt / Einbautiefe	AS 190 × 190mm / ET 130
Massangaben	201 × 201mm

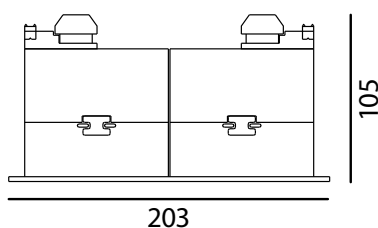

5914-75 **silber** **148.00 CHF**

Zubehör

56001	GU10 Fassung ohne Klemmbügel sonderisoliert	6.50 CHF
400500 190Q	Einbaugehäuse AS 201 × 201mm	93.00 CHF

Alle Preise excl. VRG, MwSt. und Leuchtmittel.

5688 Einbaustrahler IP44



Für Leuchtmittel Bauform	ausschliesslich PAR16 (bitte dazu bestellen)
Fassung	GU10 Fassung separat bestellen
Schutzart	IP 44
Schutzklasse	III
Material Gehäuse	Aluminium Druckguss
Einbau	Blattfedern
Ausschnitt / Einbautiefe	AS ø70mm / ET 130
Massangaben	ø83mm

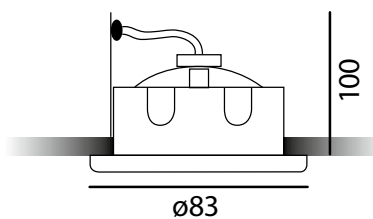

5688-01	<input type="checkbox"/> weiss	38.00 CHF
5688-04	<input type="checkbox"/> chrom	42.00 CHF
5688-05	<input type="checkbox"/> nickel satin	42.00 CHF
5688-09	<input type="checkbox"/> chrommatt	42.00 CHF

Zubehör		
56001	GU10 Fassung ohne Klemmbügel sonderisoliert	6.50 CHF
56003	GU10 Fassung mit Klemmbügel sonderisoliert	8.00 CHF

Alle Preise excl. VRG, MwSt. und Leuchtmittel.

740018 – 5W GU10 LED Retrofit Leuchtmittel

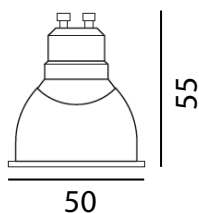

Spannung 220-240V AC, 50Hz

Schutzart IP 20

LED

Leistung 5W

Farbwiedergabe Ra 80

Dimmbar mit Phasenabschnitt

Optik Linse 38°

Massangaben ø50 × 55mm



Phasenabschnitt dimmbar mit Feller LED Universaldimmer 40200.LED

740018-27-01	2700K		380lm	<input type="checkbox"/> weiss	8.90 CHF
740018-27-75	2700K		380lm	<input type="checkbox"/> grau	8.90 CHF
740018-30-01	3000K		400lm	<input type="checkbox"/> weiss	8.90 CHF
740018-30-75	3000K		400lm	<input type="checkbox"/> grau	8.90 CHF

Alle Preise excl. MwSt. und VRG.

740018 – 5W GU10 Dim to Warm LED Retrofit Leuchtmittel

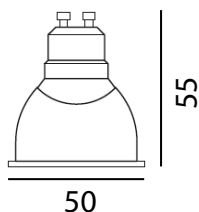

Dim to Warm Funktion
nur mit einem
Phasenabschnitt
Dimmer möglich.

Spannung 220-240V AC, 50Hz

Schutzart IP 20

LED

Leistung 5W

Farbwiedergabe Ra 80

Dimmbar mit Phasenabschnitt

Optik Linse 38°

Massangaben ø50 × 55mm



Phasenabschnitt dimmbar mit Feller LED Universaldimmer 40200.LED

740018-50-01	2200-3000K		380lm	<input type="checkbox"/> weiss	11.90 CHF
740018-50-75	2200-3000K		380lm	<input type="checkbox"/> grau	11.90 CHF

Alle Preise excl. MwSt. und VRG.

OSRAM/PHILIPS Classic – 5.3W GU10 LED Retrofit Leuchtmittel

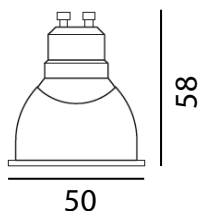

Spannung 220-240V AC, 50Hz

Schutzart IP 20

LED

Leistung 5.3W

Farbwiedergabe Ra 80

Dimmbar —

Optik Linse 36°

Massangaben ø50 × 58mm

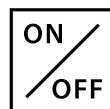

55118900 PHILIPS	2700K		345lm		14.50 CHF
941861 OSRAM	2700K		345lm		14.50 CHF

Alle Preise excl. MwSt. und VRG.

6.2W SET Retrofit LED Modul & Konverter



Spannung	220-240V AC, 50Hz (inkl. 350mA Konverter / dimmbar)
Schutzart	IP 20
Schutzklasse:	II
LED	bridgelux V8
Leistung	6.2W
Farbwiedergabe Ra	90
Optik	Reflektor
Massangaben LED Modul	ø49.8 × 48.7mm
Konverter	115 × 40 × 22mm



Phasenabschnitt dimmbar mit
Feller LED Universaldimmer
40200.LED

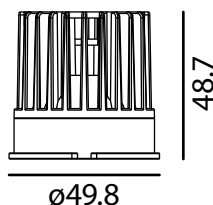

Set mit Konverter

Set mit Konverter	Color Temp	Energy Class	Beam Angle	Abstrahlwinkel	Price
740040-27-SET	2700K	A G	460lm	40°	68.00 CHF
740041-27-SET	2700K	A G	460lm	60°	68.00 CHF
740040-30-SET	3000K	A F	500lm	40°	68.00 CHF
740041-30-SET	3000K	A F	500lm	60°	68.00 CHF
740040-40-SET	4000K	A E	720lm	40°	68.00 CHF
740041-40-SET	4000K	A E	720lm	60°	68.00 CHF

Alle Preise excl. MwSt. und VRG.

6.2W DALI 2 SET Retrofit LED Modul & Konverter



Spannung	220-240V AC, 50Hz (inkl. 350mA Konverter / dimmbar)
Schutzart	IP 20
Schutzklasse:	II
LED	bridgelux V8
Leistung	6.2W
Farbwiedergabe Ra	90
Optik	Reflektor
Massangaben LED Modul	ø49.8 × 48.7mm
Konverter	111 × 36 × 25mm

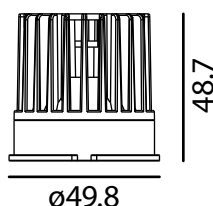

Set mit Konverter

Set mit Konverter	Color Temp	Energy Class	Beam Angle	Abstrahlwinkel	Price
740040-27-DA	2700K	A G	460lm	40°	68.00 CHF
740041-27-DA	2700K	A G	460lm	60°	68.00 CHF
740040-30-DA	3000K	A F	500lm	40°	68.00 CHF
740041-30-DA	3000K	A F	500lm	60°	68.00 CHF
740040-40-DA	4000K	A E	720lm	40°	68.00 CHF
740041-40-DA	4000K	A E	720lm	60°	68.00 CHF

Alle Preise excl. MwSt. und VRG.

9.2W SET Retrofit LED Modul & Konverter

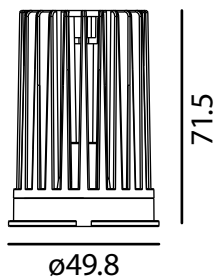

Spannung	220-240V AC, 50Hz (inkl. 500mA Konverter / dimmbar)
Schutzart	IP 20
Schutzklasse:	II
LED	bridgelux. V8
Leistung	9.2W
Farbwiedergabe Ra	90
Optik	Reflektor
Massangaben LED Modul	ø49.8 × 71.5mm
Konverter	115 × 40 × 22mm



Phasenabschnitt dimmbar mit
Feller LED Universaldimmer
40200.LED

Set mit Konverter

Set mit Konverter	Temperatur	Strahlungsart	Strahlungsleistung	Abstrahlwinkel	Preis
740042-27-SET	2700K	F	863lm	40°	68.00 CHF
740043-27-SET	2700K	F	863lm	60°	68.00 CHF
740042-30-SET	3000K	F	883lm	40°	68.00 CHF
740043-30-SET	3000K	F	883lm	60°	68.00 CHF
740042-40-SET	4000K	E	974lm	40°	auf Anfrage
740043-40-SET	4000K	E	974lm	60°	auf Anfrage

Alle Preise excl. MwSt. und VRG.

9.2W DALI SET Retrofit LED Modul & Konverter

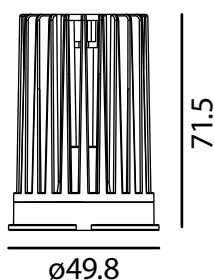

Spannung	220-240V AC, 50Hz (inkl. 500mA Konverter / dimmbar)
Schutzart	IP 20
Schutzklasse:	II
LED	bridgelux. V8
Leistung	9.2W
Farbwiedergabe Ra	90
Optik	Reflektor
Massangaben LED Modul	ø49.8 × 71.5mm
Konverter	111 × 36 × 25mm

Set mit Konverter

Set mit Konverter	Temperatur	Strahlungsart	Strahlungsleistung	Abstrahlwinkel	Preis
740042-27-DA	2700K	F	863lm	40°	68.00 CHF
740043-27-DA	2700K	F	863lm	60°	68.00 CHF
740042-30-DA	3000K	F	883lm	40°	68.00 CHF
740043-30-DA	3000K	F	883lm	60°	68.00 CHF
740042-40-DA	4000K	E	974lm	40°	auf Anfrage
740043-40-DA	4000K	E	974lm	60°	auf Anfrage

Alle Preise excl. MwSt. und VRG.

740044 / 740045 – 12.4W Retrofit Modul LED



Strom DC	450mA
	(Bitte passenden Konverter dazu bestellen)
Schutzart	IP 20
Schutzklasse:	III
LED	bridgelux V10
Leistung	12.4W
Farbwiedergabe Ra	90
Optik	Reflektor
Massangaben	ø49.8 × 71.5mm

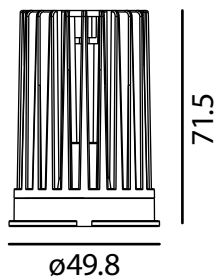

Modell	Farbtemperatur	Effizienz	Lichtstrom	Abstrahlwinkel	Preis
740044-27	2700K	A B F	1180lm	40°	54.00 CHF
740045-27	2700K	A B F	1180lm	60°	54.00 CHF
740044-30	3000K	A B F	1238lm	40°	54.00 CHF
740045-30	3000K	A B F	1238lm	60°	54.00 CHF

Alle Preise excl. MwSt. und VRG.

740044 / 740045 SET – 12.4W Retrofit LED Modul & Konverter



Spannung	220-240V AC, 50Hz
	(inkl. 450mA Konverter / dimmbar)
Schutzart	IP 20
Schutzklasse:	II
LED	bridgelux V10
Leistung	12.4W
Farbwiedergabe Ra	90
Optik	Reflektor
Massangaben LED Modul	ø49.8 × 71.5mm
Konverter	120 × 45 × 28mm

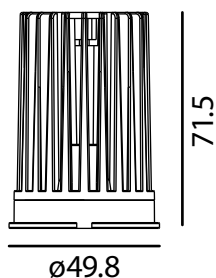

Phasenabschnitt dimmbar mit
Feller LED Universaldimmer
40200.LED

Set mit Konverter	Farbtemperatur	Effizienz	Lichtstrom	Abstrahlwinkel	Preis
740044-27-SET	2700K	A B F	11180lm	40°	72.00 CHF
740045-27-SET	2700K	A B F	11180lm	60°	72.00 CHF
740044-30-SET	3000K	A B F	11238lm	40°	72.00 CHF
740045-30-SET	3000K	A B F	11238lm	60°	72.00 CHF

Alle Preise excl. MwSt. und VRG.

740044 / 740045 SET – 13W LED Modul Dim to Warm & Konverter



Spannung	220-240V AC, 50Hz (inkl. 310mA Konverter / dimmbar)	
Schutzart	IP 20	
Schutzklasse:	II	
LED	bridgelux	Vesta DTW
Leistung	13W	
Farbwiedergabe Ra	90	
Optik	Reflektor	
Massangaben LED Modul	ø49.8 × 71.5mm	
Konverter	110 × 43 × 26 mm	

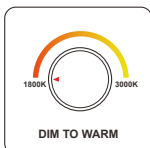

Dim to Warm Funktion nur mit einem PhasenABSchnitt Dimmer möglich.

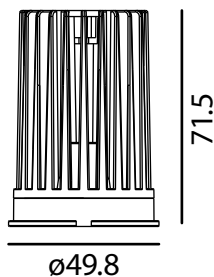

Phasenabschnitt dimmbar mit Feller LED Universaldimmer 40200.LED

Set mit Konverter

740044-50-SET	1800-3000K	A+ G	940lm	40°	86.00 CHF
740045-50-SET	1800-3000K	A+ G	940lm	60°	86.00 CHF

Abstrahlwinkel

Alle Preise excl. MwSt. und VRG.

DIM TO WARM 1800 – 3000K

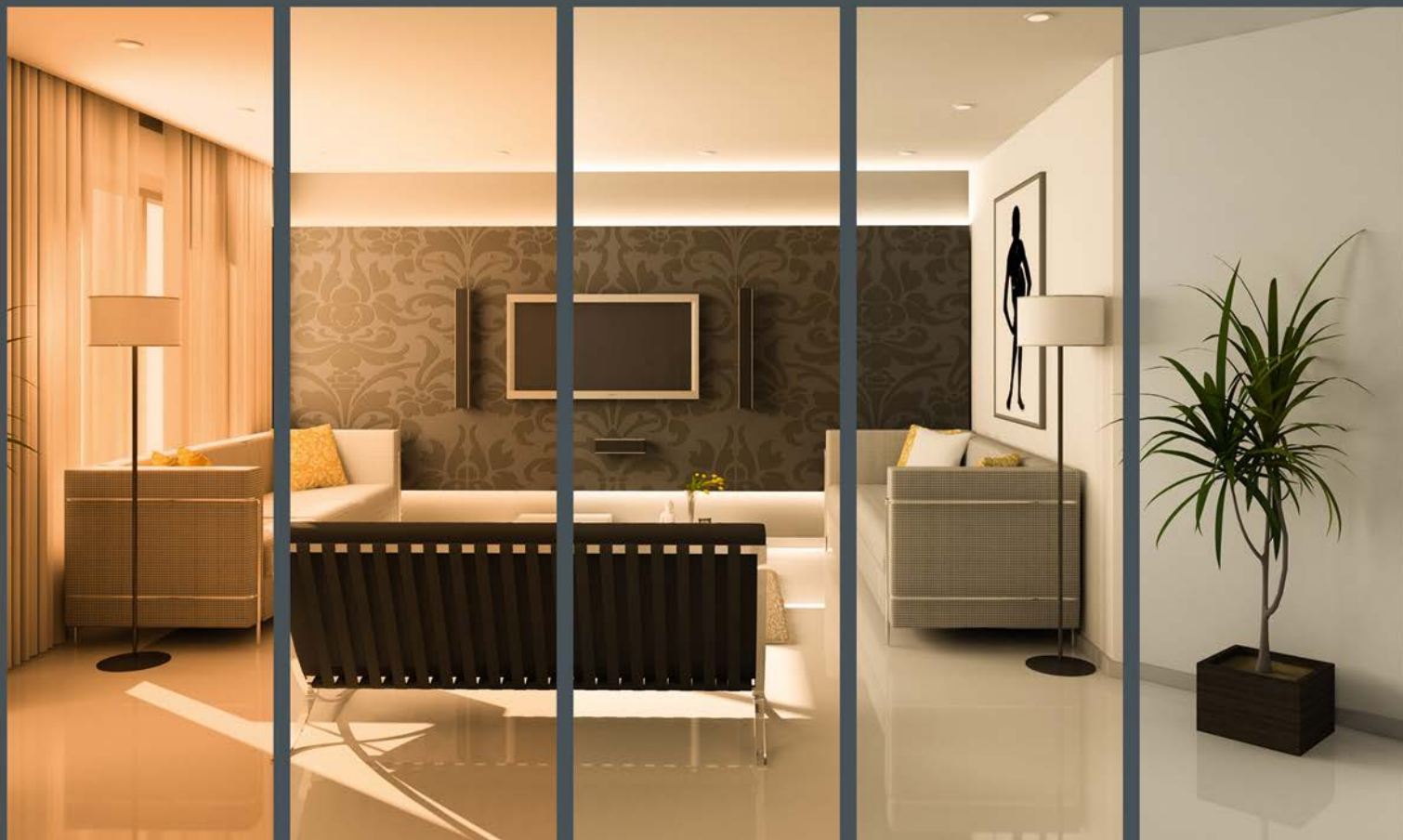



59125 – AR111 Einbaustrahler



Für Leuchtmittel Bauform	AR111 (bitte passendes Leuchtmittel dazu bestellen)
Inkl. Fassung	G53
Schutzart	IP 20
Schutzklasse	III
Leuchtmittel bis max.	100W
Material Gehäuse	Aluminium
Kardanisch	35° / 40°
Einbau	Metallwinkel
Ausschnitt / Einbautiefe	AS 152 × 152mm / ET 140mm
Massangaben	170 × 170 × 126mm

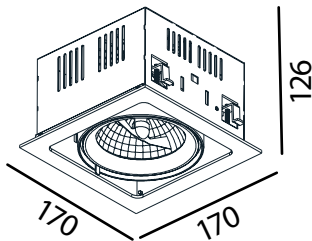

59125-00	weiss matt	98.00 CHF
59125-14	silber-schwarz	98.00 CHF

Zubehör

300400 151	Einbaugehäuse AS 152 × 152mm	78.00 CHF
------------	------------------------------	-----------

Alle Preise excl. VRG, MwSt. und Leuchtmittel.

59126 – AR111 Doppel Einbaustrahler



Für Leuchtmittel Bauform	AR111 (bitte passendes Leuchtmittel dazu bestellen)
Inkl. Fassung	2 × G53
Schutzart	IP 20
Schutzklasse	III
Leuchtmittel bis max.	100W
Material Gehäuse	Aluminium
Kardanisch	35° / 40°
Einbau	Metallwinkel
Ausschnitt / Einbautiefe	AS 152 × 298mm / ET 140mm
Massangaben	170 × 320 × 126mm

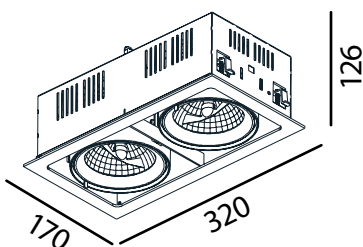

59126-00	weiss matt	148.00 CHF
59126-14	silber-schwarz	148.00 CHF

Zubehör

400500 298	Einbaugehäuse AS 152 × 298mm	93.00 CHF
------------	------------------------------	-----------

Alle Preise excl. VRG, MwSt. und Leuchtmittel.

58146 – AR111 Einbaustrahler



Für Leuchtmittel Bauform **AR111** (bitte passendes Leuchtmittel dazu bestellen)

Inkl. Fassung G53

Schutzart IP 20

Schutzklasse III

Material Gehäuse Aluminium

Dreh- und schwenkbar 350° / 30°

Einbau Spreitfedern

Ausschnitt / Einbautiefe AS ø150mm / ET 140

Massangaben 170 × 170mm

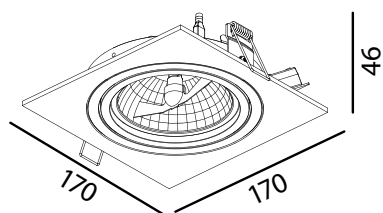

58146-16 ■ alu satin

89.00 CHF



Zubehör

310 150 Einbaugehäuse AS ø150mm

68.00 CHF

Alle Preise excl. MwSt. und VRG.

58246 – AR111 Einbaustrahler



Für Leuchtmittel Bauform **AR111** (bitte passendes Leuchtmittel dazu bestellen)

Inkl. Fassung G53

Schutzart IP 20

Schutzklasse III

Material Gehäuse Aluminium

Dreh- und schwenkbar 350° / 30°

Einbau Spreitfedern

Ausschnitt / Einbautiefe AS 150 × 320mm / ET 140

Massangaben 170 × 340mm

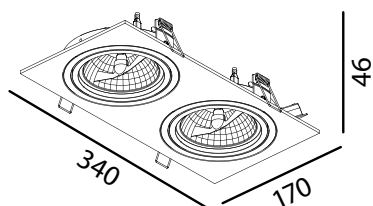

58246-16 ■ alu satin

148.00 CHF

Zubehör

400500 320 Einbaugehäuse AS 150 × 320mm

93.00 CHF

Alle Preise excl. MwSt. und VRG.

740025 – 15W AR111 Retrofit Modul LED

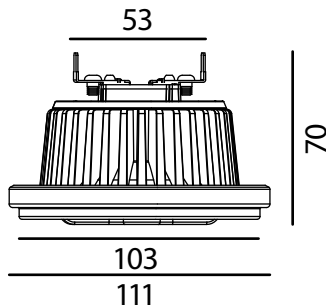

Strom DC	350mA (Bitte passenden Konverter dazu bestellen)
Schutzart	IP 20
Schutzklasse:	III
LED	CITILED The Light Engine
Leistung	15W
Farbwiedergabe Ra	92
Optik	Reflektor
Massangaben	ø111 × 70mm

				Abstrahlwinkel	
740025-36-27	2700K		850lm	36°	98.00 CHF
740025-48-27	2700K		850lm	48°	98.00 CHF
740025-36-30	3000K		900lm	36°	98.00 CHF
740025-48-30	3000K		900lm	48°	98.00 CHF

Zubehör			
730008-NT	Konverter Dimmbar [R C] 9-18W 120×45×28mm		49.00 CHF
730040	Konverter Dimmbar DALI 15W 110×52×22mm		69.00 CHF

Alle Preise excl. MwSt. und VRG.

740027 – 15W AR111 Retrofit Modul LED Dim to Warm

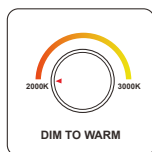
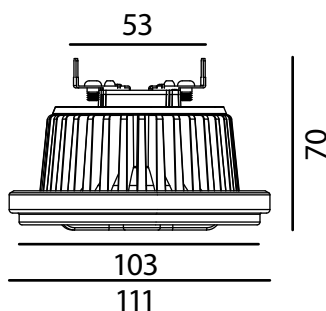

Phasenabschnitt dimmbar mit Feller LED Universaldimmer 40200.LED



Spannung	220-240V AC, 50Hz (inkl. 350mA Konverter / dimmbar)
Schutzart	IP 20
Schutzklasse:	III
LED	SHINEON
Leistung	15W
Farbwiedergabe Ra	98
Optik	Reflektor
Massangaben LED Modul	ø111 × 70mm
Konverter	120 × 45 × 28mm

Dim to Warm Funktion nur mit einem PhasenABSchnitt Dimmer möglich.



				Abstrahlwinkel	
740027-36-50-SET	2000-3000K		750lm	36°	148.00 CHF
740027-48-50-SET	2000-3000K		750lm	48°	148.00 CHF

Alle Preise excl. MwSt. und VRG.





52 74158
[RC] & DALI SET



53 74155/56
Tunable White



54 74150



55 74155/56



57 74150
[RC] & DALI SET



58 74155/56
[RC] & DALI SET



59 74155/56 BF
[RC] & DALI SET



61 74108



63 74184



63 74037



65 74137



67 74138



67 74146



68 74038



68 75038



69 75138

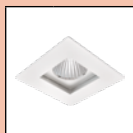

69 75146



71 59052
Line 5



71 59053
Line 10



73 59040
Line 5 JS



73 59041
Line 10 JS



75 59020



75 59022



77 59028



77 59029



79 59030



79 59031



81 59023

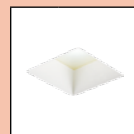

83 59025

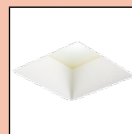

83 59027



85 56088



85 56188



87 5643



87 5644



89 750010



89 740010



90 74053



91 56090



92 750020



92 750030



93 750040



94 74042



94 74043



95 74044



95 74046

Deckeneinbauleuchten

74155-50 / 74156-50 DA – 8.9W CCT Einbaustrahler SET IP44



Tunable White

DIM
PUSH

DIM
DALI

DALI DT8 dimmbar mit Feller Power-Drehgeber TW 40085.DALI



\varnothing 80

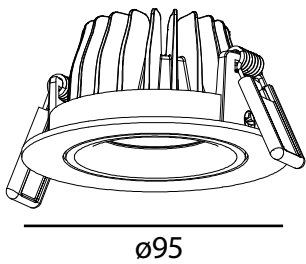

Spannung	220-240V AC, 50Hz (inkl. 500mA Konverter / dimmbar)		
Schutzart	IP 44		
Schutzklasse:	III		
LED	bridgelux.	V8 Gen 7	
Leistung	8.9W		
Farbwiedergabe Ra	90		
Optik	Reflektor, Schutzglas klar		
Schwenkbar	20°		
Material Gehäuse	Aluminium		
Einbau	Spreizfedern		
Ausschnitt / Einbautiefe	AS \varnothing 80mm / ET 70mm		
Massangaben Strahler	\varnothing 95 × 50mm		
Konverter	120 × 52 × 23mm		

						Abstrahlwinkel	
New	74155-50-00 DA	1800-4000K		1011lm		weiss matt	36° 158.00 CHF
New	74155-50-02 DA	1800-4000K		1011lm		schwarz matt	36° 158.00 CHF
New	74156-50-00 DA	1800-4000K		1011lm		weiss matt	60° 158.00 CHF
New	74156-50-02 DA	1800-4000K		1011lm		schwarz matt	60° 158.00 CHF

Alle Preise excl. MwSt. und VRG.

Betriebsart DALI DT8

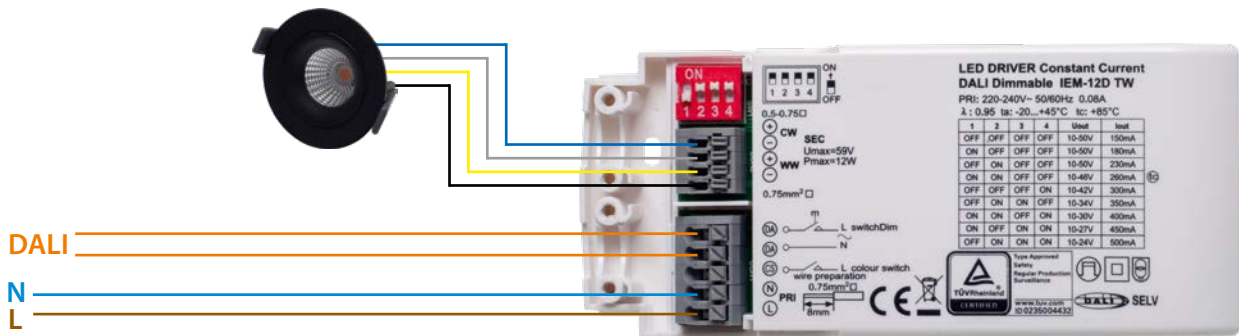

Betriebsart Push-Dim

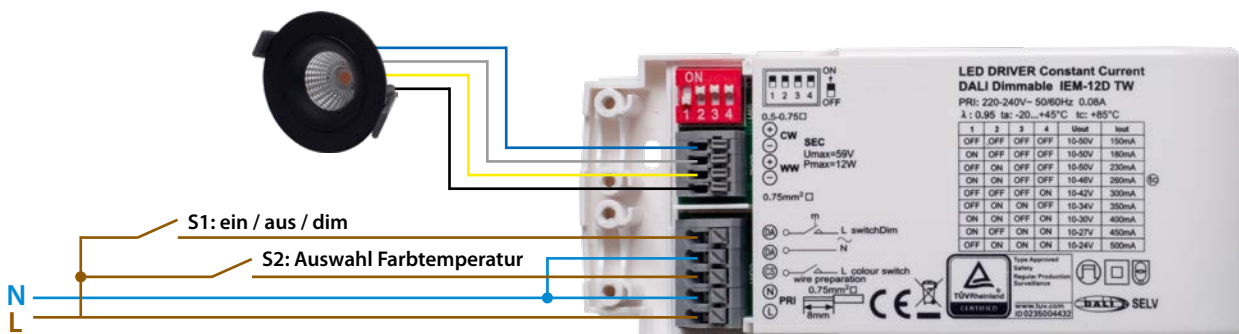

74150 – 6.1W 35mm Einbaustrahler IP44

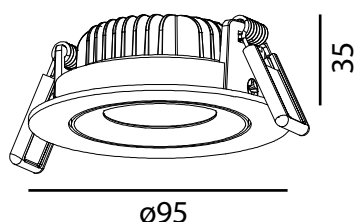

ø95

35



Strom DC	350mA
	(Bitte passenden Konverter dazu bestellen)
Schutzart	IP 44
Schutzklasse:	III
LED	bridgelux. V8 Gen 7
Leistung	6.1W
Farbwiedergabe Ra	90
Optik	Reflektor, Schutzglas klar
Schwenkbar	20°
Material Gehäuse	Aluminium
Einbau	Spreizfedern
Ausschnitt / Einbautiefe	AS ø80mm / ET 50mm
Massangaben	ø95 × 35mm

					Abstrahlwinkel	
74150-27-00	2700K		727lm	<input type="checkbox"/> weiss matt	36°	74.00 CHF
74150-30-00	3000K		757lm	<input type="checkbox"/> weiss matt	36°	74.00 CHF

Zubehör

74150-RF15	15° Reflektor	auf Anfrage
74150-RF24	24° Reflektor	auf Anfrage
74150-RF60	60° Reflektor	auf Anfrage
730040	Konverter DALI 20W 111×52×22mm	69.00 CHF
205080	Einbaugehäuse mit Tank AS ø80mm	52.00 CHF

Alle Preise excl. MwSt. und VRG.



74150 – 6.1W 35mm Einbaustrahler SET IP44

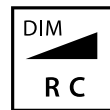

Phasenabschnitt dimmbar mit
Feller LED Universaldimmer
40200.LED

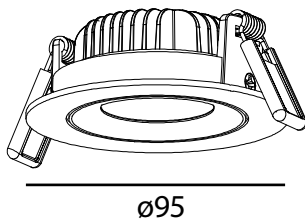

Spannung	220-240V AC, 50Hz (inkl. 350mA Konverter / dimmbar)
Schutzart	IP 44
Schutzklasse:	III

LED	bridgelux	V8 Gen 7
Leistung	6.1W	
Farbwiedergabe Ra	90	
Optik	Reflektor, Schutzglas klar	
Schwenkbar	20°	
Material Gehäuse	Aluminium	
Einbau	Spreizfedern	
Ausschnitt / Einbautiefe	AS ø80mm / ET 50mm	
Massangaben Strahler	ø95 × 35mm	
Konverter	115 × 40 × 22mm	

						Abstrahlwinkel	
	74150-27-00-SET	2700K		727lm		weiss matt	36° 94.00 CHF
New	74150-27-02-SET	2700K		727lm		schwarz matt	36° 94.00 CHF
New	74150-27-05-SET	2700K		727lm		nickel satin	36° 94.00 CHF
	74150-30-00-SET	3000K		757lm		weiss matt	36° 94.00 CHF
New	74150-30-02-SET	3000K		757lm		schwarz matt	36° 94.00 CHF
New	74150-30-05-SET	3000K		757lm		nickel satin	36° 94.00 CHF

Alle Preise excl. MwSt. und VRG.

74150-DA – 6.1W 35mm Einbaustrahler SET IP44

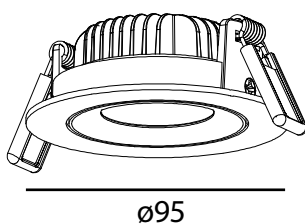

Spannung	220-240V AC, 50Hz (inkl. 350mA Konverter / dimmbar)
Schutzart	IP 44
Schutzklasse:	III

LED	bridgelux	V8 Gen 7
Leistung	6.1W	
Farbwiedergabe Ra	90	
Optik	Reflektor, Schutzglas klar	
Schwenkbar	20°	
Material Gehäuse	Aluminium	
Einbau	Spreizfedern	
Ausschnitt / Einbautiefe	AS ø80mm / ET 50mm	
Massangaben Strahler	ø95 × 35mm	
Konverter	111 × 36 × 25mm	

						Abstrahlwinkel	
New	74150-27-00 DA	2700K		727lm		weiss matt	36° 120.00 CHF
New	74150-27-02 DA	2700K		727lm		schwarz matt	36° 120.00 CHF
New	74150-27-05 DA	2700K		727lm		nickel satin	36° 120.00 CHF
New	74150-30-00 DA	3000K		757lm		weiss matt	36° 120.00 CHF
New	74150-30-02 DA	3000K		757lm		schwarz matt	36° 120.00 CHF
New	74150-30-05 DA	3000K		757lm		nickel satin	36° 120.00 CHF

Alle Preise excl. MwSt. und VRG.



74108 – 6.1W Einbaustrahler für 50mm Ausschnitt IP44

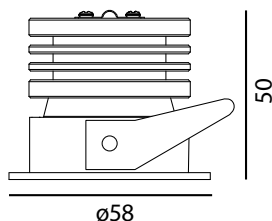

Strom DC	350mA (Bitte passenden Konverter dazu bestellen)
Schutzart	IP 44
Schutzklasse:	III
LED	bridgelux V8 Gen 7
Leistung	6.1W
Farbwiedergabe Ra	90
Optik	Linse
Schwenkbar	30°
Material Gehäuse	Aluminium
Einbau	Spreizfedern
Ausschnitt / Einbautiefe	AS ø80mm / ET 50mm
Massangaben	ø95 × 35mm

						Abstrahlwinkel	
74108-36-27-00	2700K		727lm	<input type="checkbox"/> weiss matt	36°		86.00 CHF
74108-36-27-02	2700K		727lm	<input type="checkbox"/> schwarz matt	36°		86.00 CHF
74108-36-30-00	3000K		757lm	<input type="checkbox"/> weiss matt	36°		86.00 CHF
74108-36-30-02	3000K		757lm	<input type="checkbox"/> schwarz matt	36°		86.00 CHF

Zubehör

730050-U	Konverter dim [RC] 350mA 4-9W 115×40×22mm	36.00 CHF
730040	Konverter DALI 20W 111×52×22mm	69.00 CHF

Alle Preise excl. MwSt. und VRG.



74184 – 9.2W Einbaustrahler LED

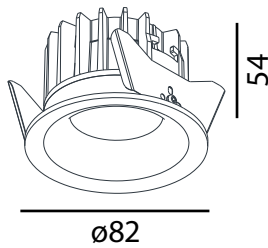

Strom DC	500mA (Bitte passenden Konverter dazu bestellen)
Schutzart	IP 20
Schutzklasse:	III
LED	bridgelux. V8
Leistung	9.2W
Farbwiedergabe Ra	90
Optik	Reflektor 32° Schutzglas klar
Material Gehäuse	Alu Druckguss
Montage	Blattfedern
Ausschnitt / Einbautiefe	AS ø65mm / ET 70
Massangaben	ø82 × 54mm

74184-27-00	2700K		863lm	<input type="checkbox"/> weiss matt	64.00 CHF
74184-27-02	2700K		863lm	<input checked="" type="checkbox"/> schwarz matt	64.00 CHF
74184-30-00	3000K		883lm	<input type="checkbox"/> weiss matt	64.00 CHF
74184-30-02	3000K		883lm	<input checked="" type="checkbox"/> schwarz matt	64.00 CHF

Zubehör

730050-U	Konverter dim [RC] 350mA 4-9W 115×40×22mm	36.00 CHF
730040	Konverter DALI 15W 111×52×22mm	69.00 CHF

Alle Preise excl. MwSt. und VRG.

74037 – 6.2W / 9.3W Einbaustrahler LED

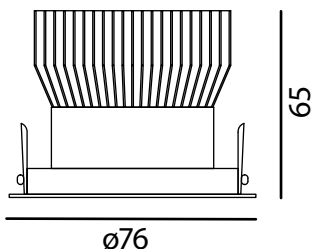
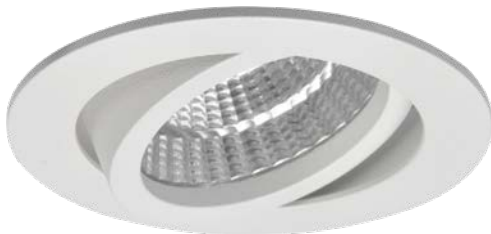

Strom DC	350 / 500mA (Bitte passenden Konverter dazu bestellen)
Schutzart	IP 20
Schutzklasse:	III
LED	bridgelux. V8
Leistung	6.2W / 9.3W
Farbwiedergabe Ra	90
Optik	Reflektor 45° Schutzglas klar
Schwenkbar	20°
Material Gehäuse	Alu Druckguss
Montage	Blattfedern
Ausschnitt / Einbautiefe	AS ø68mm / ET 85
Massangaben	ø76 × 65mm

			350mA (6.2W)		500mA (9.3W)		
74037-27-00	2700K		494lm		663lm	<input type="checkbox"/> weiss matt	68.00 CHF
74037-27-00	2700K		494lm		663lm	<input checked="" type="checkbox"/> schwarz matt	68.00 CHF
74037-27-75	2700K		494lm		663lm	<input type="checkbox"/> silberfarbig	68.00 CHF
74037-30-00	3000K		515lm		705lm	<input type="checkbox"/> weiss matt	68.00 CHF
74037-30-00	3000K		515lm		705lm	<input checked="" type="checkbox"/> schwarz matt	68.00 CHF
74037-30-75	3000K		515lm		705lm	<input type="checkbox"/> silberfarbig	68.00 CHF
74037-40-00	4000K		630lm		847lm	<input type="checkbox"/> weiss matt	68.00 CHF
74037-40-75	4000K		630lm		847lm	<input type="checkbox"/> silberfarbig	68.00 CHF

Zubehör

730051-U	Konverter dim [RC] 500mA 6-12W 115×40×22mm	36.00 CHF
730040	Konverter DALI 20W 111×52×22mm	69.00 CHF

Alle Preise excl. MwSt. und VRG.



74137 – 10.5W Einbaustrahler LED

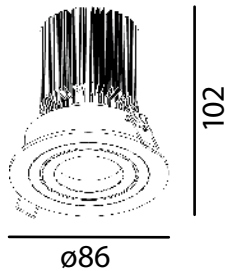

Strom DC	500mA
	(Bitte passenden Konverter dazu bestellen)
Schutzart	IP 20
Schutzklasse:	III
LED	bridgelux. ES Rectangle COB
Leistung	10.5W
Farbwiedergabe Ra	80
Optik	Reflektor 50° Schutzglas klar
Schwenkbar	20°
Material Gehäuse	Alu Druckguss
Montage	Spreizfedern
Ausschnitt / Einbautiefe	AS ø68mm / ET 120
Massangaben	ø85 × 102mm

74137-27-00	2700K		910lm	<input type="checkbox"/> weiss matt	84.00 CHF
74137-30-00	3000K		1010lm	<input type="checkbox"/> weiss matt	84.00 CHF

Zubehör

730051-U	Konverter dim [RC] 500mA 6-12W 115×40×22mm	36.00 CHF
730040	Konverter DALI 20W 111×52×22mm	69.00 CHF

Alle Preise excl. MwSt. und VRG.

74137 – 9.2W Einbaustrahler LED

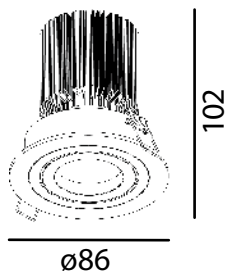

Strom DC	500mA
	(Bitte passenden Konverter dazu bestellen)
Schutzart	IP 20
Schutzklasse:	III
LED	bridgelux. V8
Leistung	9.2W
Farbwiedergabe Ra	90
Optik	Reflektor 32°/48° Schutzglas klar
Schwenkbar	28°
Material Gehäuse	Alu Druckguss
Montage	Blattfedern
Ausschnitt / Einbautiefe	AS ø68mm / ET 120
Massangaben	ø85 × 102mm

					Abstrahlwinkel	
74137-27-32-00	2700K		863lm	<input type="checkbox"/> weiss matt	32°	84.00 CHF
74137-27-48-00	2700K		863lm	<input type="checkbox"/> weiss matt	48°	84.00 CHF
74137-30-32-00	3000K		883lm	<input type="checkbox"/> weiss matt	32°	84.00 CHF
74137-30-48-00	3000K		883lm	<input type="checkbox"/> weiss matt	48°	84.00 CHF

Zubehör

730051-U	Konverter dim [RC] 500mA 6-12W 115×40×22mm	36.00 CHF
730040	Konverter DALI 20W 111×52×22mm	69.00 CHF

Alle Preise excl. MwSt. und VRG.



74138 – 10.5W Einbaustrahler LED IP44

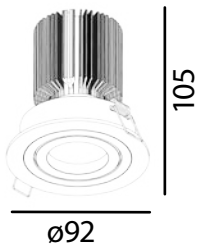

Strom DC	500mA	(Bitte passenden Konverter dazu bestellen)
Schutzart	IP 44	
Schutzklasse:	III	
LED	bridgelux.	ES Rectangle COB
Leistung	10.5W	
Farbwiedergabe Ra	80	
Optik	Reflektor 50° Schutzglas klar	
Dreh- und schwenkbar	350° / 28°	
Material Gehäuse	Alu Druckguss	
Montage	Spreizfedern	
Ausschnitt / Einbautiefe	AS ø80mm / ET 125	
Massangaben	ø92 × 105mm	

74138-27-00	2700K		910lm	<input type="checkbox"/> weiss matt	84.00 CHF
74138-27-11	2700K		910lm	<input type="checkbox"/> alu satin	84.00 CHF
74138-30-00	3000K		1010lm	<input type="checkbox"/> weiss matt	84.00 CHF
74138-30-11	3000K		1010lm	<input type="checkbox"/> alu satin	84.00 CHF

Zubehör

730051-U	Konverter dim [RC] 500mA 6-12W 115×40×22mm	36.00 CHF
730040	Konverter DALI 20W 111×52×22mm	69.00 CHF

Alle Preise excl. MwSt. und VRG.

74146 – 10.5W Einbaustrahler LED IP44

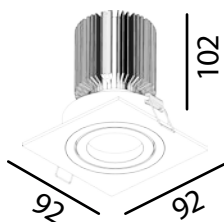
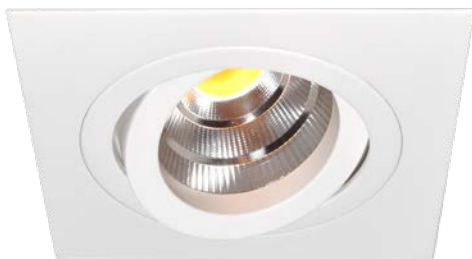

Strom DC	500mA	(Bitte passenden Konverter dazu bestellen)
Schutzart	IP 44	
Schutzklasse:	III	
LED	bridgelux.	ES Rectangle COB
Leistung	10.5W	
Farbwiedergabe Ra	80	
Optik	Reflektor 50° Schutzglas klar	
Dreh- und schwenkbar	350° / 28°	
Material Gehäuse	Alu Druckguss	
Montage	Spreizfedern	
Ausschnitt / Einbautiefe	AS ø80mm / ET 120	
Massangaben	ø92 × 102mm	

74146-27-00	2700K		910lm	<input type="checkbox"/> weiss matt	84.00 CHF
74146-27-11	2700K		910lm	<input type="checkbox"/> alu satin	84.00 CHF
74146-30-00	3000K		1010lm	<input type="checkbox"/> weiss matt	84.00 CHF
74146-30-11	3000K		1010lm	<input type="checkbox"/> alu satin	84.00 CHF

Zubehör

730051-U	Konverter dim [RC] 500mA 6-12W 115×40×22mm	36.00 CHF
730040	Konverter DALI 20W 111×52×22mm	69.00 CHF

Alle Preise excl. MwSt. und VRG.

74038 – 9.2W Einbaustrahler LED



Strom DC	350mA (Bitte passenden Konverter dazu bestellen)
Schutzart	IP 20
Schutzklasse:	III

LED **EPISTAR**

Leistung	9.2W
Farbwiedergabe Ra	80
Optik	Reflektor 60° / Schutzglas matt
Schwenkbar	30°
Material Gehäuse	Alu Druckguss
Montage	Blattfedern
Ausschnitt / Einbautiefe	AS ø80mm / ET 75
Massangaben	ø95 × 56mm

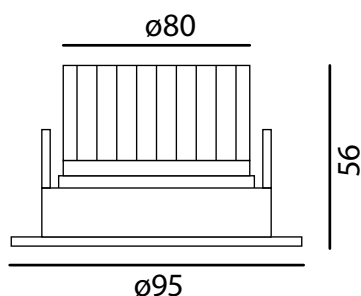

2700K 500lm 3000K 560lm

74038-27-01	74038-30-01	<input type="checkbox"/> weiss	78.00 CHF
74038-27-03	—	<input checked="" type="checkbox"/> gold	84.00 CHF
74038-27-04	—	<input type="checkbox"/> chrom	84.00 CHF
74038-27-05	74038-30-05	<input type="checkbox"/> nickel satin	84.00 CHF
74038-27-09	—	<input type="checkbox"/> chrommatt	84.00 CHF

Zubehör

730050	Konverter dim [RC] 350mA 6-12W 98×39×22mm	29.00 CHF
730040	Konverter DALI 15W 111×52×22mm	69.00 CHF

Alle Preise excl. MwSt. und VRG.

75038 – 9.3W Einbaustrahler LED



Strom DC	500mA (Bitte passenden Konverter dazu bestellen)
Schutzart	IP 20
Schutzklasse:	III

LED **ES Star COB**

Leistung	9.3W
Farbwiedergabe Ra	80
Optik	Reflektor 32° / Blendfrei
Schwenkbar	20°
Material Gehäuse	Alu Druckguss
Montage	Spreizfedern
Ausschnitt / Einbautiefe	AS ø80mm / ET 115
Massangaben	ø100 × 95mm

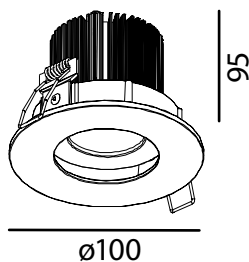

75038-27-00	2700K 835lm	<input type="checkbox"/> weiss matt	128.00 CHF
75038-27-02	2700K 835lm	<input checked="" type="checkbox"/> schwarz matt	128.00 CHF
75038-30-00	3000K 870lm	<input type="checkbox"/> weiss matt	128.00 CHF
75038-30-02	3000K 870lm	<input checked="" type="checkbox"/> schwarz matt	128.00 CHF

Zubehör

730051-U	Konverter dim [RC] 500mA 6-12W 115×40×22mm	36.00 CHF
730040	Konverter DALI 20W 111×52×22mm	69.00 CHF
205080	Einbaugehäuse mit Tank AS ø80mm	52.00 CHF

Alle Preise excl. MwSt. und VRG.

75138 – 15W Einbaustrahler LED

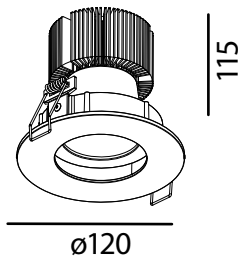

Strom DC	500mA
	(Bitte passenden Konverter dazu bestellen)
Schutzart	IP 20
Schutzklasse:	III
LED	bridgelux. ES Rectangle COB
Leistung	15W
Farbwiedergabe Ra	80
Optik	Reflektor 44° / Blendfrei
Schwenkbar	20°
Material Gehäuse	Alu Druckguss
Montage	Spreizfedern
Ausschnitt / Einbautiefe	AS ø95mm / ET 135
Massangaben	ø120 × 115mm

75138-30-00 **3000K** 1440lm weiss matt **144.00 CHF**

Zubehör

730048	Konverter dim [RC] 500mA 5-18W 113×44×28mm	49.00 CHF
730040	Konverter DALI 20W 111×52×22mm	69.00 CHF
205095	Einbaugehäuse mit Tank AS ø95mm	84.00 CHF

Alle Preise excl. MwSt. und VRG.

75146 – 15W Einbaustrahler LED

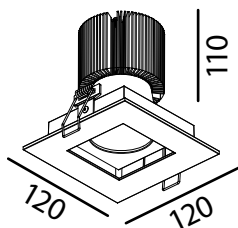

Strom DC	500mA
	(Bitte passenden Konverter dazu bestellen)
Schutzart	IP 20
Schutzklasse:	III
LED	bridgelux. ES Rectangle COB
Leistung	15W
Farbwiedergabe Ra	80
Optik	Reflektor 44° / Blendfrei
Schwenkbar	20°
Material Gehäuse	Alu Druckguss
Montage	Spreizfedern
Ausschnitt / Einbautiefe	AS 95 × 95mm / ET 135
Massangaben	120 × 120 × 115mm

75146-30-00 **3000K** 1440lm weiss matt **148.00 CHF**

Zubehör

730048	Konverter dim [RC] 500mA 5-18W 113×44×28mm	49.00 CHF
730040	Konverter DALI 20W 111×52×22mm	69.00 CHF
200403	Einbaugehäuse mit Tank AS 95 × 95mm	14.00 CHF

Alle Preise excl. MwSt. und VRG.



59052 – 10W Line 5 Einbaustrahler



Strom DC	700mA (Bitte passenden Konverter dazu bestellen)
Schutzart	IP 20
Schutzklasse:	III
LED	OSLON Square
Leistung	5 × 2W
Farbwiedergabe Ra	80
Optik	Reflektor 48° Schutzglas klar
Material Gehäuse	Aluminium
Einbau	Spreizfedern
Ausschnitt / Einbautiefe	AS130 × 36mm / ET 75mm
Massangaben	137 × 44 × 52mm

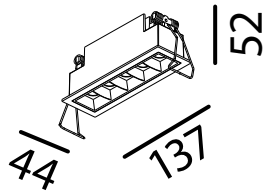

		Gehäuse	Reflektor	
59052-30-12	3000K 1250lm	<input type="checkbox"/> weiss matt	<input checked="" type="checkbox"/> schwarz	138.00 CHF
59052-RF-00	Zusatz Reflektor	—	<input type="checkbox"/> weiss	35.00 CHF
59052-RF-03	Zusatz Reflektor	—	<input checked="" type="checkbox"/> gold	35.00 CHF

Zubehör		
730040	Konverter DALI 20W 111×52×22mm	69.00 CHF
59052-Eb	Einbaugehäuse AS 130×36mm	98.00 CHF

Lieferzeit ca. 2–3 Wochen. Alle Preise excl. MwSt. und VRG.

59053 – 20W Line 10 Einbaustrahler



Strom DC	700mA (Bitte passenden Konverter dazu bestellen)
Schutzart	IP 20
Schutzklasse:	III
LED	OSLON Square
Leistung	10 × 2W
Farbwiedergabe Ra	80
Optik	Reflektor 48° Schutzglas klar
Material Gehäuse	Aluminium
Einbau	Spreizfedern
Ausschnitt / Einbautiefe	AS 250 × 36mm / ET 75mm
Massangaben	257 × 44 × 52mm

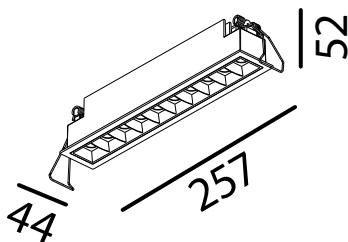

		Gehäuse	Reflektor	
59053-30-12	3000K 2500lm	<input type="checkbox"/> weiss matt	<input checked="" type="checkbox"/> schwarz	248.00 CHF
59053-RF-00	Zusatz Reflektor	—	<input type="checkbox"/> weiss	35.00 CHF
59053-RF-03	Zusatz Reflektor	—	<input checked="" type="checkbox"/> gold	35.00 CHF

Zubehör		
730040	Konverter DALI 20W 111×52×22mm	69.00 CHF
59053-Eb	Einbaugehäuse AS 250×36mm	98.00 CHF

Lieferzeit ca. 2–3 Wochen. Alle Preise excl. MwSt. und VRG.



59040 – 10W Line 5 JS Einbaustrahler



Strom DC	700mA (Bitte passenden Konverter dazu bestellen)
Schutzart	IP 20
Schutzklasse:	III
LED	OSLON Square
Leistung	5 × 2W
Farbwiedergabe Ra	80
Optik	Reflektor 48° Schutzglas klar
Schwenkbar	45°
Material Gehäuse	Aluminium
Einbau	Spreizfedern
Ausschnitt / Einbautiefe	AS 144 × 76mm / ET 110mm
Massangaben	155 × 83 × 78mm

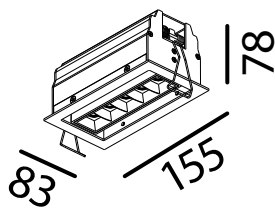

		Gehäuse	Reflektor	
59040-30-12	3000K 1250lm	<input type="checkbox"/> weiss matt	<input checked="" type="checkbox"/> schwarz	184.00 CHF
59052-RF-00	Zusatz Reflektor	—	<input type="checkbox"/> weiss	35.00 CHF
59052-RF-03	Zusatz Reflektor	—	<input checked="" type="checkbox"/> gold	35.00 CHF

Zubehör

730040	Konverter DALI 20W 111×52×22mm	69.00 CHF
59040-Eb	Einbaugehäuse AS 143×76mm	98.00 CHF

Lieferzeit ca. 2–3 Wochen. Alle Preise excl. MwSt. und VRG.

59041 – 20W Line 10 JS Einbaustrahler



Strom DC	700mA (Bitte passenden Konverter dazu bestellen)
Schutzart	IP 20
Schutzklasse:	III
LED	OSLON Square
Leistung	10 × 2W
Farbwiedergabe Ra	80
Optik	Reflektor 48° Schutzglas klar
Schwenkbar	45°
Material Gehäuse	Aluminium
Einbau	Spreizfedern
Ausschnitt / Einbautiefe	AS 265 × 76mm / ET 110mm
Massangaben	275 × 83 × 78mm

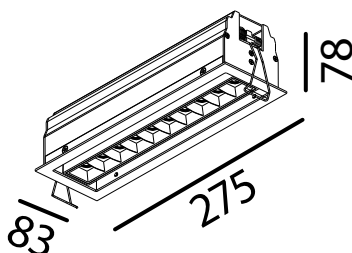

		Gehäuse	Reflektor	
59041-30-12	3000K 2500lm	<input type="checkbox"/> weiss matt	<input checked="" type="checkbox"/> schwarz	328.00 CHF
59053-RF-00	Zusatz Reflektor	—	<input type="checkbox"/> weiss	35.00 CHF
59053-RF-03	Zusatz Reflektor	—	<input checked="" type="checkbox"/> gold	35.00 CHF

Zubehör

730040	Konverter DALI 20W 111×52×22mm	69.00 CHF
59041-EB	Einbaugehäuse AS 265×76mm	98.00 CHF

Lieferzeit ca. 2–3 Wochen. Alle Preise excl. MwSt. und VRG.



59020 – 9.2W Einbaustrahler

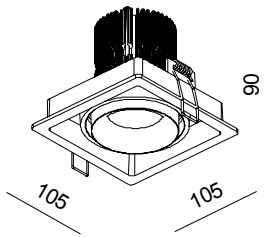

59020-27-12	2700K		863lm		weiss matt / schwarz	149.00 CHF
59020-27-14	2700K		863lm		silberfarbig / schwarz	149.00 CHF
59020-30-12	3000K		883lm		weiss matt / schwarz	149.00 CHF
59020-30-14	3000K		883lm		silberfarbig / schwarz	149.00 CHF

Zubehör

730051-U	Konverter dim [RC] 500mA 6-12W 115x40x22mm	36.00 CHF
730040	Konverter DALI 20W 111x52x22mm	69.00 CHF
205400 93	Einbaugehäuse mit Tank AS 93x93mm	34.00 CHF

Alle Preise excl. MwSt. und VRG.



Strom DC	500mA (Bitte passenden Konverter dazu bestellen)
Schutzart	IP 20
Schutzklasse:	III
LED	bridgelux. V8
Leistung	9.2W
Farbwiedergabe Ra	90
Optik	Reflektor 45° Schutzglas klar
Dreh- und schwenkbar	355° / 22°
Material Gehäuse	Aluminium
Einbau	Spreizfedern
Ausschnitt / Einbautiefe	AS 93 x 93mm / ET 116mm
Massangaben	105 x 105 x 90mm

59022 – 2 x 9.2W Einbaustrahler

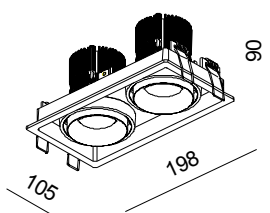

59022-27-12	2700K		2 x 863lm		weiss matt / schwarz	258.00 CHF
59022-27-14	2700K		2 x 863lm		silberfarbig / schwarz	258.00 CHF
59022-30-12	3000K		2 x 883lm		weiss matt / schwarz	258.00 CHF
59022-30-14	3000K		2 x 883lm		silberfarbig / schwarz	258.00 CHF

Zubehör

730051-U	Benötigt 2x Konverter dim [RC] 500mA 6-12W 115x40x22mm	2 x 36.00 CHF
730040	Konverter DALI 20W Leuchten in Serie schalten!	69.00 CHF
310400-185	Einbaugehäuse AS 93x185mm	78.00 CHF

Alle Preise excl. MwSt. und VRG.



Strom DC	500mA (Bitte passenden Konverter dazu bestellen)
Schutzart	IP 20
Schutzklasse:	III
LED	bridgelux. V8
Leistung	2 x 9.2W
Farbwiedergabe Ra	90
Optik	Reflektor 45° Schutzglas klar
Dreh- und schwenkbar	355° / 22°
Material Gehäuse	Aluminium
Einbau	Spreizfedern
Ausschnitt / Einbautiefe	AS 93 x 185mm / ET 116mm
Massangaben	198 x 105 x 90mm



59028 – 9.2W Einbaustrahler für Sichtbeton

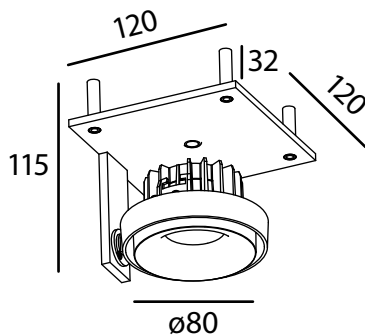

Spannung	220-240V AC, 50Hz (inkl. 500mA Konverter / dimmbar)
Schutzart	IP 20
Schutzklasse:	II
LED	bridgelux. V8
Leistung	9.2W
Farbwiedergabe Ra	90
Optik	Reflektor 45° Schutzglas klar
Kardanisch	45° / 30°
Material Gehäuse	Aluminium
Einbau	Direkt geschraubt
Ausschnitt / Einbautiefe	AS 125 × 125mm / ET 115mm
Massangaben	120 × 120 × 115mm



Phasenabschnitt dimmbar mit
Feller LED Universaldimmer
40200.LED

59028-27-75	2700K	863lm	silberfarbig	178.00 CHF
59028-30-75	3000K	883lm	silberfarbig	178.00 CHF

Zubehör

59028-EB	Einbaugehäuse AS 125 × 125mm	54.00 CHF
----------	------------------------------	-----------

Alle Preise excl. MwSt. und VRG.

59029 – 2 × 9.2W Einbaustrahler für Sichtbeton

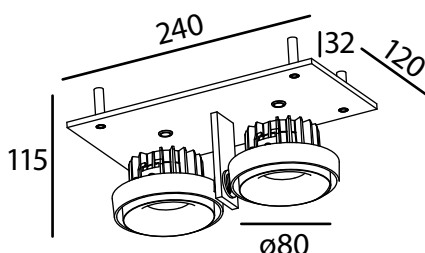

Spannung	220-240V AC, 50Hz (inkl. 500mA Konverter / dimmbar)
Schutzart	IP 20
Schutzklasse:	II
LED	bridgelux. V8
Leistung	2 × 9.2W
Farbwiedergabe Ra	90
Abstrahlwinkel	45°
Optik	Reflektor 45° Schutzglas klar
Kardanisch	45° / 30°
Material Gehäuse	Aluminium
Einbau	Direkt geschraubt
Ausschnitt / Einbautiefe	AS 125 × 245mm / ET 115mm
Massangaben	240 × 120 × 115mm



Phasenabschnitt dimmbar mit
Feller LED Universaldimmer
40200.LED

59029-27-75	2700K	2 × 863lm	silberfarbig	342.00 CHF
59029-30-75	3000K	2 × 883lm	silberfarbig	342.00 CHF

Zubehör

59029-EB	Einbaugehäuse AS 125 × 255mm	64.00 CHF
----------	------------------------------	-----------

Alle Preise excl. MwSt. und VRG.



59030 – 9.2W Einbaustrahler LED randlos

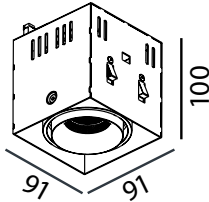
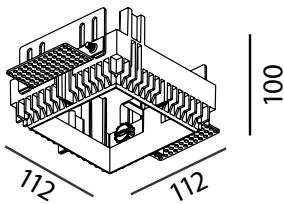

Strom DC **500mA**
(Bitte passenden Konverter dazu bestellen)

Schutzart IP 20

Schutzklasse: III

LED **bridgelux** V8

Leistung 9.2W

Farbwiedergabe Ra 90

Optik Reflektor 45° Schutzglas

Material Gehäuse Aluminium

Einbau Montage Rahmen randlos

Ausschnitt / Einbautiefe AS 114 × 114mm / ET 116

Massangaben 91 × 91 × 96mm

• Inklusive Montage Rahmen für den Deckeneinbau

59030-27-00	2700K		863lm		weiss matt	178.00 CHF
59030-27-12	2700K		863lm		weiss / schwarz	178.00 CHF
59030-30-00	3000K		883lm		weiss matt	178.00 CHF
59030-30-12	3000K		883lm		weiss / schwarz	178.00 CHF

Zubehör

730051-U	Konverter dim [RC] 500mA 6-12W 115×40×22mm	36.00 CHF
730040	Konverter DALI 20W 111×52×22mm	69.00 CHF
59030-EB	Einbaugehäuse	119.00 CHF

Alle Preise excl. MwSt. und VRG.

59031 – 2 × 9.2W Einbaustrahler LED randlos

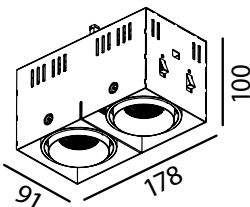
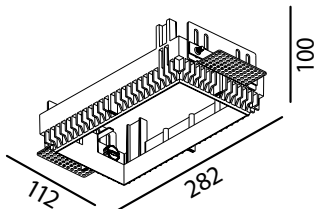

Strom DC **500mA**
(Bitte passenden Konverter dazu bestellen)

Schutzart IP 20

Schutzklasse: III

LED **bridgelux** V8

Leistung 2 × 9.2W

Farbwiedergabe Ra 90

Optik Reflektor 45° Schutzglas klar

Material Gehäuse Aluminium

Einbau Montage Rahmen randlos

Ausschnitt / Einbautiefe AS 204 × 114mm / ET 120

Massangaben 91 × 178 × 100mm

• Inklusive Montage Rahmen für den Deckeneinbau

59031-27-00	2700K		2 × 863lm		weiss matt	284.00 CHF
59031-27-12	2700K		2 × 863lm		weiss / schwarz	284.00 CHF
59031-30-00	3000K		2 × 883lm		weiss matt	284.00 CHF
59031-30-12	3000K		2 × 883lm		weiss / schwarz	284.00 CHF

Zubehör

730051-U	Benötigt 2×	Konverter dim [RC] 500mA 6-12W 115×40×22mm	36.00 CHF
730040		Konverter DALI 20W Leuchten in Serie schalten!	69.00 CHF
59031-EB		Einbaugehäuse	119.00 CHF

Alle Preise excl. MwSt. und VRG.



59023 – 9.2W Einbaustrahler starr randlos

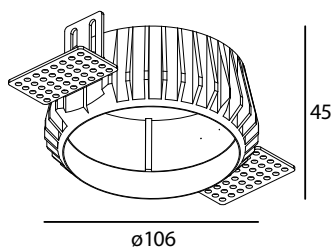

Inklusive Montagerahmen

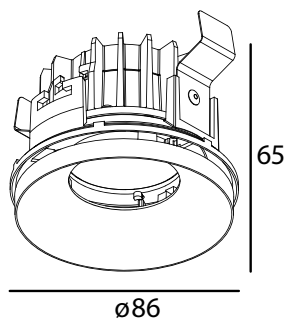

Strom DC	500mA
(Bitte passenden Konverter dazu bestellen)	
Schutzart	IP 20
Schutzklasse:	III
LED	bridgelux V8
Leistung	9.2W
Farbwiedergabe Ra	90
Optik	Reflektor 45° Schutzglas klar
Material Gehäuse	Aluminium
Einbau	Montagerahmen
Ausschnitt / Einbautiefe	AS ø114mm / ET 85mm
Massangaben	ø86 × 65mm



59023-27-00	2700K	863lm	<input type="checkbox"/> weiss matt	174.00 CHF
59023-30-00	3000K	883lm	<input type="checkbox"/> weiss matt	174.00 CHF

Zubehör			
730051-U	Konverter dim [RC] 500mA 6-12W 115×40×22mm		29.00 CHF
730040	Konverter DALI 20W 111×52×22mm		69.00 CHF
59023-EB	Einbaugehäuse AS ø114mm		98.00 CHF

Alle Preise excl. MwSt. und VRG.

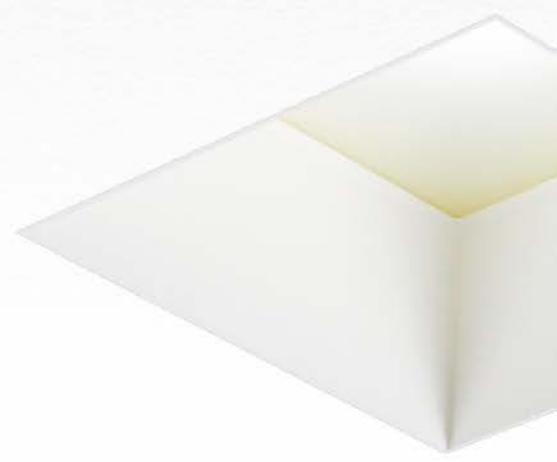
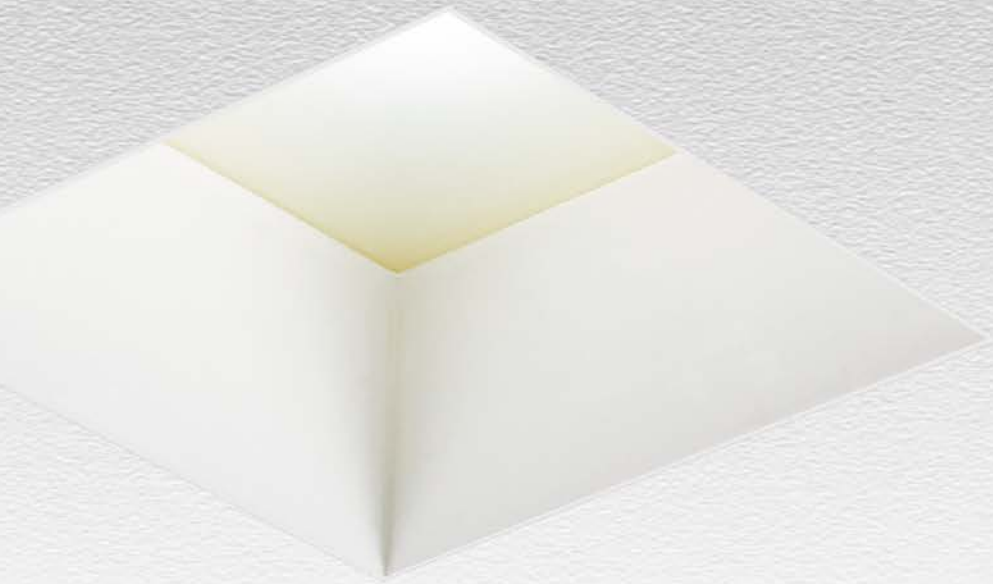

59025 – 9.8W Einbaustrahler LED randlos

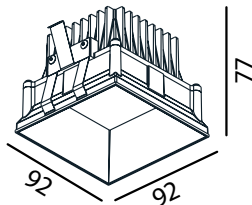
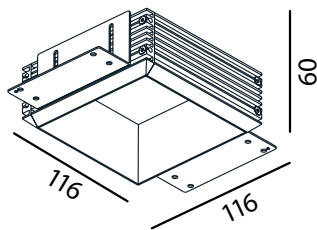

59025-27-00	2700K		912lm	<input type="checkbox"/> weiss matt	159.00 CHF
59025-30-00	3000K		950lm	<input type="checkbox"/> weiss matt	159.00 CHF
59025-40-00	4000K		1210lm	<input type="checkbox"/> weiss matt	159.00 CHF

Zubehör

730051-U	Konverter dim [RC] 500mA 6-12W 115×40×22mm	36.00 CHF
730040	Konverter DALI 20W 111×52×22mm	69.00 CHF
59025-EB	Einbaugehäuse	98.00 CHF

Alle Preise excl. MwSt. und VRG.



Strom DC **500mA**
(Bitte passenden Konverter dazu bestellen)

Schutzart IP 20

Schutzklasse: III

LED **PHILIPS** LUXEON

Leistung 9.8W

Farbwiedergabe Ra 80

Optik PMMA Opal Abdeckung

Material Gehäuse Aluminium

Einbau Montage Rahmen randlos

Ausschnitt / Einbautiefe AS 118 × 118mm / ET 100

Massangaben 92 × 92 × 77mm

• Inklusive Montage Rahmen für den Deckeneinbau

59027 – 16.2W Einbaustrahler LED randlos

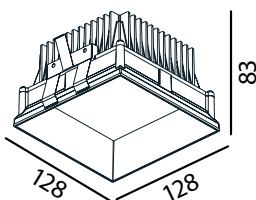
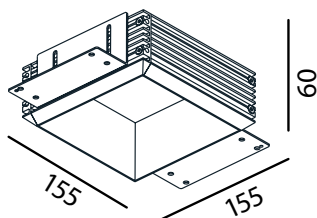

59027-27-00	2700K		1480lm	<input type="checkbox"/> weiss matt	198.00 CHF
59027-30-00	3000K		1539lm	<input type="checkbox"/> weiss matt	198.00 CHF
59027-40-00	4000K		1712lm	<input type="checkbox"/> weiss matt	198.00 CHF

Zubehör

730048	Konverter dim [RC] 500mA 5-18W 113×44×28mm	49.00 CHF
730040	Konverter DALI 20W 111×52×22mm	69.00 CHF
59027-EB	Einbaugehäuse	108.00 CHF

Alle Preise excl. MwSt. und VRG.



Strom DC **500mA**
(Bitte passenden Konverter dazu bestellen)

Schutzart IP 20

Schutzklasse: III

LED **PHILIPS** LUXEON

Leistung 16.2W

Farbwiedergabe Ra 80

Optik PMMA Opal Abdeckung

Material Gehäuse Aluminium

Einbau Montage Rahmen randlos

Ausschnitt / Einbautiefe AS 154 × 154mm / ET 110

Massangaben 128 × 128 × 83mm

• Inklusive Montage Rahmen für den Deckeneinbau



56088 – 9.8W Einbaustrahler LED IP54

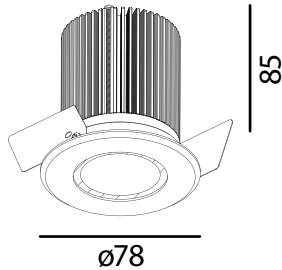

Strom DC	350mA (Bitte passenden Konverter dazu bestellen)
Schutzart	IP 54
Schutzklasse:	III
LED	bridgelux. COB
Leistung	9.8W
Farbwiedergabe Ra	80
Optik	Reflektor 38° Schutzglas klar
Material Gehäuse	Alu Druckguss
Montage	Blattfedern
Ausschnitt / Einbautiefe	AS ø68mm / ET 105
Massangaben	ø78 × 85mm

56088-30-11 **3000K** 850lm alu satin **128.00 CHF**

Zubehör

730050	Konverter dim [RC] 350mA 6-12W 98×39×22mm	29.00 CHF
730040	Konverter DALI 15W 111×52×22mm	69.00 CHF

Alle Preise excl. MwSt. und VRG.

56188 – 15W Einbaustrahler LED IP54

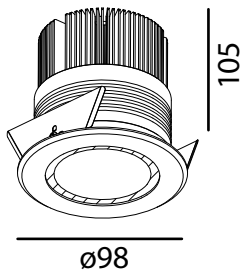

Strom DC	500mA (Bitte passenden Konverter dazu bestellen)
Schutzart	IP 54
Schutzklasse:	III
LED	bridgelux. ES Rectangle COB
Leistung	15W
Farbwiedergabe Ra	80
Optik	Reflektor 44° Schutzglas klar
Material Gehäuse	Alu Druckguss
Montage	Blattfedern
Ausschnitt / Einbautiefe	AS ø85mm / ET 125
Massangaben	ø98 × 105mm

56188-30-11 **3000K** 1440lm alu satin **148.00 CHF**

Zubehör

730048	Konverter dim [RC] 500mA 5-18W 113×44×28mm	49.00 CHF
730040	Konverter DALI 20W 111×52×22mm	69.00 CHF

Alle Preise excl. MwSt. und VRG.



5643 – 10W Einbaustrahler LED IP44

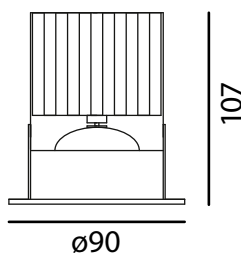

Strom DC	350mA (Bitte passenden Konverter dazu bestellen)
Schutzart	IP 44
Schutzklasse:	III
LED	Power LED
Leistung	10W
Farbwiedergabe Ra	80
Optik	Reflektor 60° / Schutzglas matt
Material Gehäuse	Aluminium
Montage	Blattfeder
Ausschnitt / Einbautiefe	AS 80mm / ET 120mm
Massangaben	ø90 × 107mm

2700K 500lm	3000K 560lm	4000K 640lm		
5643-27-00	5643-30-00	5643-40-00	<input type="checkbox"/> weiss matt	132.00 CHF
5643-27-01	5643-30-01	5643-40-01	<input type="checkbox"/> weiss	132.00 CHF
5643-27-04	5643-30-04	5643-40-04	<input type="checkbox"/> chrom	138.00 CHF
5643-27-05	5643-30-05	5643-40-05	<input type="checkbox"/> nickel satin	138.00 CHF
5643-27-09	5643-30-09	5643-40-09	<input type="checkbox"/> chrommatt	138.00 CHF
5643-27-11	5643-30-11	5643-40-11	<input type="checkbox"/> alu satin	138.00 CHF

Zubehör

730050	Konverter dim [RC] 350mA 6-12W 98×39×22mm	29.00 CHF
730040	Konverter DALI 15W 111×52×22mm	69.00 CHF

Alle Preise excl. MwSt. und VRG.

5644 – 10W Einbaustrahler LED IP44

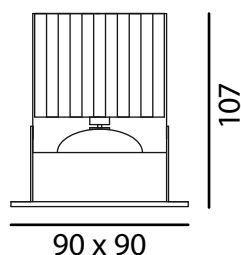

Strom DC	350mA (Bitte passenden Konverter dazu bestellen)
Schutzart	IP 44
Schutzklasse:	III
LED	Power LED
Leistung	10W
Farbwiedergabe Ra	80
Optik	Reflektor 60° / Schutzglas matt
Material Gehäuse	Aluminium
Montage	Blattfedern
Ausschnitt / Einbautiefe	AS 80mm / ET 120mm
Massangaben	90 × 90 × 107mm

2700K 500lm	3000K 560lm	4000K 640lm		
5644-27-00	5644-30-00	5644-40-00	<input type="checkbox"/> weiss matt	132.00 CHF
5644-27-01	5644-30-01	5644-40-01	<input type="checkbox"/> weiss	132.00 CHF
5644-27-04	5644-30-04	5644-40-04	<input type="checkbox"/> chrom	138.00 CHF
5644-27-05	5644-30-05	5644-40-05	<input type="checkbox"/> nickel satin	138.00 CHF
5644-27-09	5644-30-09	5644-40-09	<input type="checkbox"/> chrommatt	138.00 CHF
5644-27-11	5644-30-11	5644-40-11	<input type="checkbox"/> alu satin	138.00 CHF

Zubehör

730050	Konverter dim [RC] 350mA 6-12W 98×39×22mm	29.00 CHF
730040	Konverter DALI 15W 111×52×22mm	69.00 CHF

Alle Preise excl. MwSt. und VRG.



750010 – 10W Einbaustrahler LED IP44

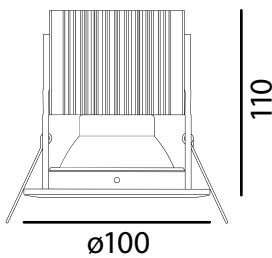

inkl. 350mA Konverter
(dimmbar)



Spannung 220-240V AC, 50Hz
(inkl. 350mA Konverter / dimmbar)

Schutzart IP 44

Schutzklasse: II

LED **EPISTAR**

Leistung 10W

Farbwiedergabe Ra 80

Optik Linse mit Reflektor 45°

Material Gehäuse Alu Druckguss

Montage Spreizfedern

Ausschnitt / Einbautiefe AS \varnothing 85mm / ET 130

Massangaben LED Strahler \varnothing 100 × 110mm

Konverter 37 × 129 × 22mm

750010-01	3000K		840lm	<input type="checkbox"/> weiss	84.00 CHF
750010-09	3000K		840lm	<input type="checkbox"/> chrommatt	84.00 CHF

Zubehör

730040	Konverter DALI 15W 111×52×22mm	69.00 CHF
205600	Einbaugehäuse mit Tank AS \varnothing ausbohrbar bis 170 mm	52.00 CHF

Alle Preise excl. MwSt. und VRG.

740010 – 10W Einbaustrahler LED IP44

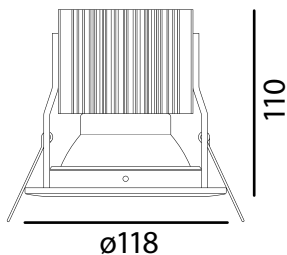

inkl. 350mA Konverter
(dimmbar)



Spannung 220-240V AC, 50Hz
(inkl. 350mA Konverter / dimmbar)

Schutzart IP 44

Schutzklasse: II

LED **EPISTAR**

Leistung 10W

Farbwiedergabe Ra 80

Optik Linse mit Reflektor 45°

Material Gehäuse Alu Druckguss

Montage Spreizfedern

Ausschnitt / Einbautiefe AS \varnothing 100mm / ET 130

Massangaben LED Strahler \varnothing 118 × 110mm

Konverter 37 × 129 × 22mm

740010-01	3000K		840lm	<input type="checkbox"/> weiss	96.00 CHF
740010-09	3000K		840lm	<input type="checkbox"/> chrommatt	96.00 CHF

Zubehör

730040	Konverter DALI 15W 111×52×22mm	69.00 CHF
205100	Einbaugehäuse mit Tank AS \varnothing 100mm	52.00 CHF

Alle Preise excl. MwSt. und VRG.

74053 – 15W Einbaustrahler LED IP44



Strom DC	450mA (inkl. 450mA Konverter / dimmbar)
Schutzart	IP 44
Schutzklasse:	II
LED	2835 SMD LED
Leistung	15W
Farbwiedergabe Ra	80
Optik	Kunststoffscheibe diffus
Material Gehäuse	Alu Druckguss
Einbau	Spreizfedern
Ausschnitt / Einbautiefe	AS ø115-120mm / ET 65mm
Massangaben	ø145 × 45.5mm

Lichttemperatur über Schiebeschalter einstellbar

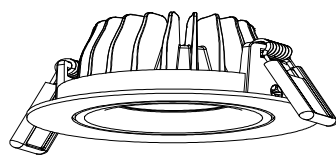

ø145

45.5



74053-50-00 **3000 / 4000 / 5000K** **AG F** 1120-1280lm weiss **124.00 CHF**

Zubehör
205120 Einbaugehäuse mit Tank AS 120mm **52.00 CHF**

Alle Preise excl. MwSt. und VRG.

56090 – 9W Einbaustrahler LED IP44

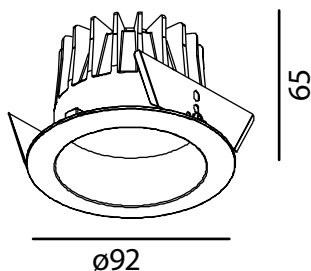

Strom DC	500mA (Bitte passenden Konverter dazu bestellen)
Schutzart	IP 44
Schutzklasse:	III
LED	PHILIPS SMD
Leistung	9W
Farbwiedergabe Ra	80
Optik	PMMA Opal Abdeckung
Material Gehäuse	Alu Druckguss
Einbau	Blattfedern
Ausschnitt / Einbautiefe	AS ø80-85mm / ET 85
Massangaben	ø92 × 65mm

56090-27-00	2700K		770lm	<input type="checkbox"/> weiss matt	84.00 CHF
56090-27-75	2700K		770lm	<input type="checkbox"/> silberfarbig	84.00 CHF
56090-30-00	3000K		855lm	<input type="checkbox"/> weiss matt	84.00 CHF
56090-30-75	3000K		855lm	<input type="checkbox"/> silberfarbig	84.00 CHF

Zubehör

730051-U	Konverter dim [RC] 500mA 6-12W 115×40×22mm	36.00 CHF
730040	Konverter DALI 20W 111×52×22mm	69.00 CHF

Alle Preise excl. MwSt. und VRG.

750020 – 10W Einbaustrahler LED IP44



Spannung	220-240V AC, 50Hz (inkl. 700mA Konverter / dimmbar)
Schutzart	IP 44
Schutzklasse:	II
LED	EPISTAR SMD
Leistung	10W
Farbwiedergabe Ra	80
Optik	PMMA Opal Abdeckung
Material Gehäuse	Alu Druckguss
Montage	Spreizfedern
Ausschnitt / Einbautiefe	AS ø140mm / ET 90
Massangaben	ø165 × 68mm

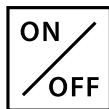
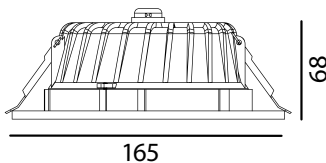

750020-00-00 **2700K** 810lm weiss matt **94.00 CHF**

Zubehör

730040	Konverter DALI 20W 111×52×22mm	69.00 CHF
205600	Einbaugehäuse mit Tank AS ø ausbohrbar bis 170mm	52.00 CHF

Alle Preise excl. MwSt. und VRG.



750030 – 15W Einbaustrahler LED IP44



Spannung	220-240V AC, 50Hz (inkl. 700mA Konverter / nicht dimmbar)
Schutzart	IP 44
Schutzklasse:	II
LED	EPISTAR SMD
Leistung	15W
Farbwiedergabe Ra	80
Optik	PMMA Opal Abdeckung
Material Gehäuse	Alu Druckguss
Montage	Spreizfedern
Ausschnitt / Einbautiefe	AS ø160mm / ET 90
Massangaben	ø190 × 68mm

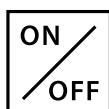
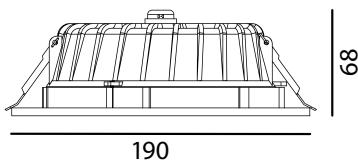

750030-00-00 **2700K** 1410lm weiss matt **112.00 CHF**

Zubehör

730040	Konverter DALI 20W 111×52×22mm	69.00 CHF
205168	Einbaugehäuse mit Tank AS ø168mm	52.00 CHF

Alle Preise excl. MwSt. und VRG.

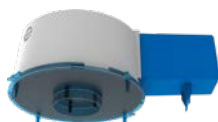

750040 – 20W Einbaustrahler LED IP44

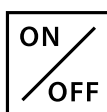
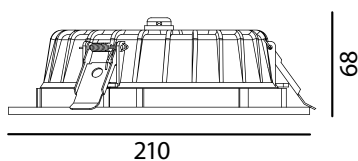

Strom DC 220-240V AC, 50Hz
(inkl. 700mA Konverter / nicht dimmbar)

Schutzart IP 44

Schutzklasse: II

LED **EPISTAR** SMD

Leistung 20W

Farbwiedergabe Ra 80

Optik PMMA Opal Abdeckung

Material Gehäuse Alu Druckguss

Montage Spreizfedern

Ausschnitt / Einbautiefe AS \varnothing 185mm / ET 90

Massangaben \varnothing 210 x 68mm

210

750040-00-00

2700K



1850lm weiss matt

124.00 CHF



Zubehör

730040

Konverter DALI | 20W | 111x52x22mm

69.00 CHF

310185

Einbaugehäuse mit Tank AS \varnothing 185mm

CHF

Alle Preise excl. MwSt. und VRG.

74042 – 20W Einbaustrahler LED IP44 inkl. Konverter



Strom DC	500mA
	(inkl. Konverter)
Schutzart	IP 44
Schutzklasse:	II
LED	CREE
Leistung	20W
Farbwiedergabe Ra	90
Optik	Reflektor 40° Schutzglas klar
Material Gehäuse	Alu Druckguss
Einbau	Spreizfedern
Ausschnitt / Einbautiefe	AS ø120mm / ET 95mm
Massangaben	ø136 × 75mm

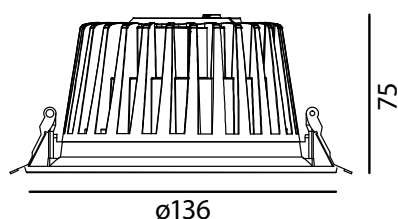

			Inkl. Konverter			
74042-30-00	3000K		1470lm	20W (on/off)	<input type="checkbox"/> weiss matt	108.00 CHF
74042-30-00DA	3000K		1470lm	DALI	<input type="checkbox"/> weiss matt	128.00 CHF



Zubehör		
205120	Einbaugehäuse mit Tank AS 120mm	52.00 CHF

Alle Preise excl. MwSt. und VRG.

74043 – 30W Einbaustrahler LED IP44 inkl. Konverter

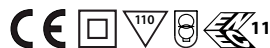

Spannung	700mA
	(inkl. Konverter)
Schutzart	IP 44
Schutzklasse:	II
LED	CREE
Leistung	22W (500mA) / 30W (700mA)
Farbwiedergabe Ra	90
Optik	Reflektor 40° Schutzglas klar
Material Gehäuse	Alu Druckguss
Einbau	Spreizfedern
Ausschnitt / Einbautiefe	AS ø155mm / ET 120mm
Massangaben	ø176 × 100mm

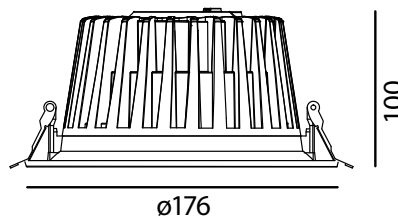

			Inkl. Konverter			
74043-30-00	3000K		2400lm	30W (on/off)	<input type="checkbox"/> weiss matt	148.00 CHF
74043-30-00DA	3000K		2400lm	DALI	<input type="checkbox"/> weiss matt	178.00 CHF

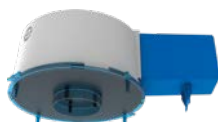

Zubehör		
205160	Einbaugehäuse mit Tank AS 160mm	52.00 CHF

Alle Preise excl. MwSt. und VRG.

74044 – 36W Einbaustrahler LED IP44 inkl. Konverter



Strom DC **900mA**
(inkl. Konverter)

Schutzart IP 44

Schutzklasse: II

LED **CREE** ⇄

Leistung 30W (700mA) / 36W (900mA)

Farbwiedergabe Ra 90

Optik Reflektor 40° Schutzglas klar

Material Gehäuse Alu Druckguss

Einbau Spreizfedern

Ausschnitt / Einbautiefe AS ø172mm / ET 125mm

Massangaben ø196 × 105mm

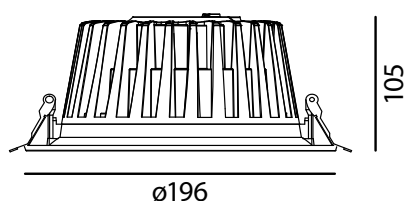

				Inkl. Konverter			
74044-30-00	3000K		2800lm	36W (on/off)	<input type="checkbox"/>	weiss matt	178.00 CHF
74044-30-00DA	3000K		2800lm	DALI	<input type="checkbox"/>	weiss matt	208.00 CHF
74044-40-00	4000K		3000lm	36W (on/off)	<input type="checkbox"/>	weiss matt	178.00 CHF
74044-40-00DA	4000K		3000lm	DALI	<input type="checkbox"/>	weiss matt	208.00 CHF



Zubehör

305175	Einbaugehäuse mit Tank AS 175mm	84.00 CHF
--------	---------------------------------	-----------

Alle Preise excl. MwSt. und VRG.

74046 – 50W Einbaustrahler LED IP44 inkl. Konverter



Strom DC **1200mA**
(inkl. Konverter)

Schutzart IP 44

Schutzklasse: II

LED **CREE** ⇄

Leistung 36W (900mA) / 50W (1200mA)

Farbwiedergabe Ra 90

Optik Reflektor 45° Schutzglas klar

Material Gehäuse Alu Druckguss

Einbau Spreizfedern

Ausschnitt / Einbautiefe AS ø210mm / ET 145mm

Massangaben ø230 × 125mm

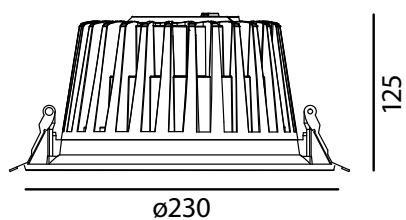

				Inkl. Konverter			
74046-30-00	3000K		3650lm	50W (on/off)	<input type="checkbox"/>	weiss matt	218.00 CHF
74046-30-00DA	3000K		3650lm	DALI	<input type="checkbox"/>	weiss matt	258.00 CHF
74046-40-00	4000K		4000lm	50W (on/off)	<input type="checkbox"/>	weiss matt	218.00 CHF
74046-40-00DA	4000K		4000lm	DALI	<input type="checkbox"/>	weiss matt	258.00 CHF



Zubehör

305210	Einbaugehäuse mit Tank AS 210mm	84.00 CHF
--------	---------------------------------	-----------

Alle Preise excl. MwSt. und VRG.





98 74033



99 74030



99 74031

Möbeleinbauleuchten



100 740021



100 740020



101 74200



103 74205



74033 – 4W Einbaustrahler LED IP44

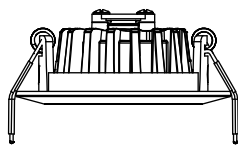

ø68

36.5

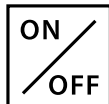

Spannung 220-240V AC, 50Hz
(inkl. 350mA Konverter / nicht dimmbar)

Schutzart IP 44

Schutzklasse: II

LED **CREE** ⇄

Leistung 4W

Farbwiedergabe Ra 90

Optik Reflektor 25° Schutzglas klar

Schwenkbar 30°

Material Gehäuse Alu Druckguss

Einbau Spreizfedern

Ausschnitt / Einbautiefe AS ø60mm / ET 45mm

Massangaben ø68 × 36.5mm

74033-27-00	2700K	AG	G	300lm	weiss matt	84.00 CHF
74033-27-02	2700K	AG	G	300lm	schwarz matt	84.00 CHF
74033-30-00	3000K	AG	F	330lm	weiss matt	84.00 CHF
74033-30-02	3000K	AG	F	330lm	schwarz matt	84.00 CHF

Zubehör

730040	Konverter DALI 20W 111×52×22mm	69.00 CHF
35200	Einbaugehäuse AS ø0–70mm	23.00 CHF

Alle Preise excl. MwSt. und VRG.

74030 – 4W Einbaustrahler LED IP44

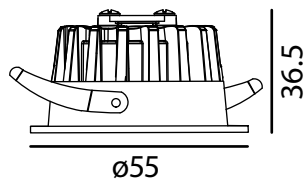
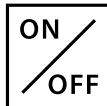

Spannung	220-240V AC, 50Hz (inkl. 350mA Konverter / nicht dimmbar)
Schutzart	IP 44
Schutzklasse:	II
LED	CREE
Leistung	4W
Farbwiedergabe Ra	90
Optik	Reflektor 24° Schutzglas klar
Material Gehäuse	Alu Druckguss
Einbau	Blattfedern
Ausschnitt / Einbautiefe	AS ø52mm / ET 45mm
Massangaben	ø55 × 36.5mm

74030-27-00	2700K		300lm	<input type="checkbox"/> weiss matt	78.00 CHF
74030-27-02	2700K		300lm	<input type="checkbox"/> schwarz matt	78.00 CHF
74030-30-00	3000K		330lm	<input type="checkbox"/> weiss matt	78.00 CHF
74030-30-02	3000K		330lm	<input type="checkbox"/> schwarz matt	78.00 CHF

Zubehör

730040	Konverter DALI 20W 111×52×22mm	69.00 CHF
35200	Einbaugehäuse AS ø0–70mm	23.00 CHF

Alle Preise excl. MwSt. und VRG.

74031 – 4W Einbaustrahler LED IP44

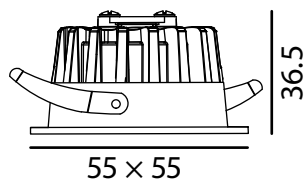
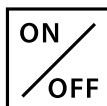

Spannung	220-240V AC, 50Hz (inkl. 350mA Konverter / nicht dimmbar)
Schutzart	IP 44
Schutzklasse:	II
LED	CREE
Leistung	4W
Farbwiedergabe Ra	90
Optik	Reflektor 24° Schutzglas klar
Material Gehäuse	Alu Druckguss
Einbau	Blattfedern
Ausschnitt / Einbautiefe	AS ø52mm / ET 45mm
Massangaben	55 × 55 × 36.5mm

74031-27-00	2700K		300lm	<input type="checkbox"/> weiss matt	78.00 CHF
74031-30-00	3000K		330lm	<input type="checkbox"/> weiss matt	78.00 CHF

Zubehör

730040	Konverter DALI 20W 111×52×22mm	69.00 CHF
35200	Einbaugehäuse AS ø0–70mm	23.00 CHF

Alle Preise excl. MwSt. und VRG.

740021 – 1.2W Einbaustrahler LED



Strom DC	12V DC
	(Bitte passenden Konverter dazu bestellen)
Schutzart	IP 20
Schutzklasse:	III
LED	COB LED
Leistung	1.2W
Farbwiedergabe Ra	80
Optik	Linse 100°
Material Gehäuse	Alu Druckguss
Montage	Blattfedern
Ausschnitt / Einbautiefe	AS ø28mm / ET 30
Massangaben	ø32 × 25mm

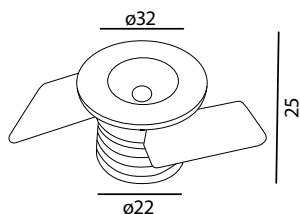

New	740021-27-00	2700K	60lm	weiss matt	42.00 CHF
New	740021-27-75	2700K	60lm	silberfarbig	42.00 CHF
New	740021-30-00	3000K	67lm	weiss matt	42.00 CHF
New	740021-30-75	3000K	67lm	silberfarbig	42.00 CHF

Alle Preise excl. MwSt. und VRG.

740020 – 3.6W Einbaustrahler LED



Strom DC	12V DC
	(Bitte passenden Konverter dazu bestellen)
Schutzart	IP 20
Schutzklasse:	III
LED	COB LED
Leistung	3.6W
Farbwiedergabe Ra	80
Optik	Linse 30°
Material Gehäuse	Alu Druckguss
Montage	Blattfedern
Ausschnitt / Einbautiefe	AS ø28mm / ET 40
Massangaben	ø32 × 37mm

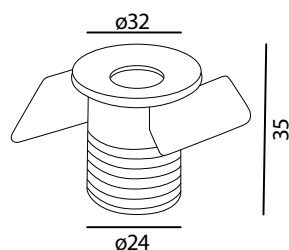

New	740020-27-00	2700K	84lm	weiss matt	48.00 CHF
New	740020-27-75	2700K	84lm	silberfarbig	48.00 CHF
New	740020-30-00	3000K	97lm	weiss matt	48.00 CHF
New	740020-30-75	3000K	97lm	silberfarbig	48.00 CHF

Alle Preise excl. MwSt. und VRG.

74200 – 3W Einbaustrahler LED

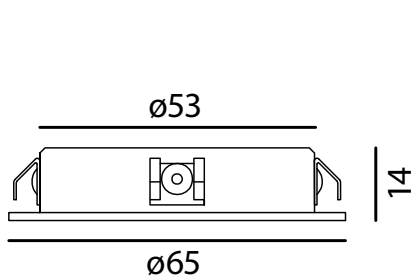

Strom DC	12V DC (Bitte passenden Konverter dazu bestellen)
Schutzart	IP 20
Schutzklasse:	III
LED	COB LED
Leistung	3W
Farbwiedergabe Ra	80
Optik	Reflektor Schutzglas matt
Material Gehäuse	Alu Druckguss
Montage	Spreizfedern
Ausschnitt / Einbautiefe	AS ø60mm / ET 25 (Einbautiefe beachten!)
Massangaben	ø65 × 14mm

74200-27-00	2700K		180lm	<input type="checkbox"/> weiss matt	39.00 CHF
74200-27-13	2700K		180lm	<input type="checkbox"/> alu eloxiert	39.00 CHF
74200-30-00	3000K		200lm	<input type="checkbox"/> weiss matt	39.00 CHF
74200-30-13	3000K		200lm	<input type="checkbox"/> alu eloxiert	39.00 CHF



Zubehör					
74201-01	Ring für Aufbaumontage	<input type="checkbox"/> weiss			3.00 CHF
74201-13	Ring für Aufbaumontage	<input type="checkbox"/> alu eloxiert			3.00 CHF

Alle Preise excl. MwSt. und VRG.

3W 12V DC LED Konverter



Schutzart	IP 20
Primärseitig	100-240V AC 50/60Hz
Messpunkt tc	80°C
Dimmbar	—
Abmessungen	50 × 33 × 18mm



74203	12V DC	3W	Vorverkabelt	29.00 CHF
-------	--------	----	--------------	-----------

Alle Preise excl. MwSt. und VRG.

8W/18W 12V DC LED Konverter



Schutzart	IP 20
Primärseitig	100-240V AC 50/60Hz
Messpunkt tc	75°C
Dimmbar	—
Abmessungen	L × 44 × 15mm



mit Stromkabel und 6-fach Verteiler

74204	12V DC	8W	110mm	für 1–3 Leuchten	38.00 CHF
74205	12V DC	18W	149mm	für 4–6 Leuchten	42.00 CHF

Alle Preise excl. MwSt. und VRG.



74205 – 3.2W Einbaustrahler



Strom DC **350mA***
(Bitte passenden Konverter dazu bestellen)

Schutzart IP 44

Schutzklasse: II

LED **bridgelux** V6

Leistung 3.2W

Farbwiedergabe Ra 90

Optik Linse 36°/60° (24° auf Anfrage)

Material Gehäuse Aluminium

Einbau Blattfedern

Ausschnitt / Einbautiefe AS ø58mm / ET 20

Massangaben ø68 × 18mm



Zusammen mit Anbauring

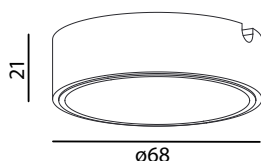
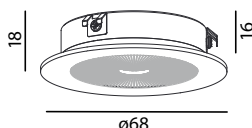

						Abstrahlwinkel	
74205-36-27-00	2700K		320lm		weiss matt	36°	42.00 CHF
74205-36-27-02	2700K		320lm		schwarz matt	36°	42.00 CHF
74205-36-27-05	2700K		320lm		nickel satin	36°	46.00 CHF
74205-36-27-75	2700K		320lm		silberfarbig	36°	42.00 CHF
74205-36-30-00	3000K		334lm		weiss matt	36°	42.00 CHF
74205-36-30-02	3000K		334lm		schwarz matt	36°	42.00 CHF
74205-36-30-05	3000K		334lm		nickel satin	36°	46.00 CHF
74205-36-30-75	3000K		334lm		silberfarbig	36°	42.00 CHF
74205-60-27-00	2700K		320lm		weiss matt	60°	42.00 CHF
74205-60-27-02	2700K		320lm		schwarz matt	60°	42.00 CHF
74205-60-27-05	2700K		320lm		nickel satin	60°	46.00 CHF
74205-60-27-75	2700K		320lm		silberfarbig	60°	42.00 CHF
74205-60-30-00	3000K		334lm		weiss matt	60°	42.00 CHF
74205-60-30-02	3000K		334lm		sschwarz matt	60°	42.00 CHF
74205-60-30-05	3000K		334lm		nickel satin	60°	46.00 CHF
74205-60-30-75	3000K		334lm		silberfarbig	60°	42.00 CHF

Anbauring

74209-00		weiss matt	6.00 CHF
74209-02		schwarz matt	6.00 CHF
74209-05		nickel satin	8.00 CHF
74209-75		silberfarbig	6.00 CHF

Zubehör

74214	Konverter mit 4-fach Verteiler 350mA 1-4 Leuchten	41.00 CHF
74215	Konverter mit 6-fach Verteiler 350mA 5-6 Leuchten	46.00 CHF
730040	Konverter DALI 20W 111×52×22mm 1-6 Leuchten	50.00 CHF
74210-01-00	1m Leuchtenkabel Verlängerung	3.90 CHF
74210-1.5-00	1.5m Leuchtenkabel Verlängerung	5.50 CHF
74210-02-00	2m Leuchtenkabel Verlängerung	4.60 CHF
74210-4-VT	4-fach Verteiler mit 1.5m Kabel	4.50 CHF
74210-6-VT	6-fach Verteiler mit 1.5m Kabel	6.50 CHF
Überbrückungs Jumper für Mehrfach-Verteiler		

Alle Preise excl. MwSt. und VRG.





107 5570



107 5516



108 5561



109 5520



109 5521

Wandeinbauleuchten



5570 – 3W Wandeinbaustrahler LED



Strom DC **700mA**
(Bitte passenden Konverter dazu bestellen)

Schutzart IP 20

Schutzklasse: III

LED **CREE**

Leistung 3W

Farbwiedergabe Ra 80

Lichtaustritt Asymmetrisch

Material Gehäuse Alu Druckguss

Einbau Blattfedern

Ausschnitt / Einbautiefe AS 75 × 75mm / ET 83

Massangaben 86 × 86 × 63mm

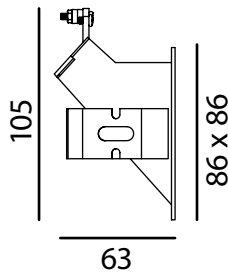

5570-01	3000K		140lm	<input type="checkbox"/> weiss	98.00 CHF
5570-75	3000K		140lm	<input checked="" type="checkbox"/> silberfarbig	98.00 CHF

Zubehör

73007	Konverter 700mA 3.5W 58×39×20mm	32.20 CHF
5565 Bx	Box für Wandeinbau	36.00 CHF
5214 Pk	Putzrahmen für Einbaubox	28.00 CHF

Alle Preise excl. MwSt. und VRG.

5516 – 1.2W Wandeinbaustrahler LED



Strom DC **350mA**
(Bitte passenden Konverter dazu bestellen)

Schutzart IP 20

Schutzklasse: III

LED **OSRAM**

Leistung 1.2W

Farbwiedergabe Ra 80

Lichtaustritt Asymmetrisch

Material Gehäuse Alu Druckguss

Einbau Blattfedern

Ausschnitt / Einbautiefe AS 76 × 76mm / ET 50

Massangaben 90 × 90 × 31mm

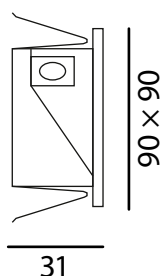

5516-75	3000K		56lm	<input checked="" type="checkbox"/> silberfarbig	79.00 CHF
---------	-------	--	------	--	-----------

Zubehör

5565 Bx	Box für Wandeinbau	36.00 CHF
5214 Pk	Putzrahmen für Einbaubox	28.00 CHF

Alle Preise excl. MwSt. und VRG.



5561 – 3W Wandeinbaustrahler LED



Strom DC **700mA**
(Bitte passenden Konverter dazu bestellen)

Schutzart IP 20

Schutzklasse: III

LED **CREE** ⇄

Leistung 3W

Farbwiedergabe Ra 80

Optik Schutzglas matt

Material Gehäuse Alu Druckguss

Einbau Blattfedern

Ausschnitt / Einbautiefe AS 68 × 68mm / ET 50mm

Massangaben 80 × 80 × 31mm

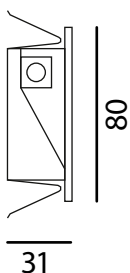
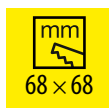

5561-30-01	3000K		140lm	<input type="checkbox"/> weiss	96.00 CHF
5561-30-13	3000K		140lm	<input checked="" type="checkbox"/> alu eloxiert	96.00 CHF

Zubehör

73007	Konverter 700mA 3.5W 58×39×20mm	32.20 CHF
5565 Bx	Box für Wandeinbau	36.00 CHF
5565 Pk	Putzrahmen für Einbaubox	28.00 CHF

Alle Preise excl. MwSt. und VRG.

5520 – 2.5W Wandeinbaustrahler LED



Spannung	220-240V AC, 50Hz (inkl. 700mA Konverter / nicht dimmbar)
Schutzart	IP 20
Schutzklasse:	III
LED	CREE XP-E
Leistung	2.5W
Farbwiedergabe Ra	80
Lichtaustritt	Asymmetrisch
Material Gehäuse	Alu Druckguss
Einbau	Blattfedern
Ausschnitt / Einbautiefe	AS 65 × 65mm / ET 65
Massangaben	76 × 76 × 45mm

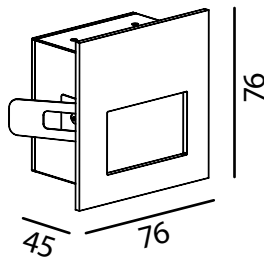

5520-16 **2700K** 120lm alu satin **79.00 CHF**

Zubehör

5565 Bx	Box für Wandeinbau	36.00 CHF
5565 Pk	Putzrahmen für Einbaubox	28.00 CHF

Alle Preise excl. MwSt. und VRG.

5521 – 2.5W Wandeinbaustrahler LED



Spannung	220-240V AC, 50Hz (inkl. 700mA Konverter / nicht dimmbar)
Schutzart	IP 20
Schutzklasse:	III
LED	CREE XP-E
Leistung	2.5W
Farbwiedergabe Ra	80
Lichtaustritt	Asymmetrisch
Material Gehäuse	Alu Druckguss
Einbau	Blattfedern
Ausschnitt / Einbautiefe	AS 170 × 45mm / ET60
Massangaben	184 × 56 × 41mm

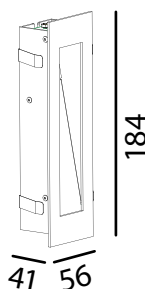

5521-16 **2700K** 120lm alu satin **98.00 CHF**

Zubehör

5202 Bx	Box für Wandeinbau	39.00 CHF
5521 Pk	Putzrahmen für Einbaubox	32.00 CHF

Alle Preise excl. MwSt. und VRG.





113 59039



115 59035

Tube



116 59038

Tube



117 59036

Tube



119 59033

Tube



121 95028

Turn In



121 56040



123 75040



123 75041

Halbeinbauleuchten



59039 – 12.2W Tube Anbaustrahler mit Einbaumodul



Strom DC **350mA**
(Bitte passenden Konverter dazu bestellen)

Schutzart IP 20

Schutzklasse: III

LED **bridgelux** V10c

Leistung 12.2W

Farbwiedergabe Ra 90

Optik Reflektor 48° Schutzglas klar

Dreh- und schwenkbar 355° / 90°

Material Gehäuse Aluminium

Einbau Spreizfedern

Ausschnitt / Einbautiefe AS ø60–68mm / ET 30mm

Massangaben ø80 × 90mm

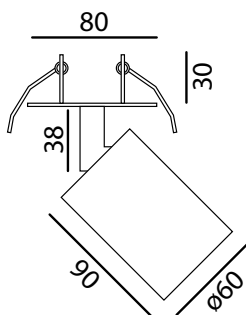

2700K 1456lm **3000K** 1525lm

59039-27-00	59039-30-00	weiss matt	146.00 CHF
59039-27-02	59039-30-02	schwarz matt	146.00 CHF
59039-27-75	59039-30-75	silberfarbig	146.00 CHF

Zubehör

730008-NT	Konverter dim [RC] 350mA	39.00 CHF
730040	Konverter DALI 20W 111×52×22mm	69.00 CHF
95055-RF60-30	Reflektor transparent	8.50 CHF
95055-RF60-30	Reflektor gold	8.50 CHF
95055-RF60-30	Reflektor schwarz	8.50 CHF

Filter

95055-SF60	Soft Filter	8.50 CHF
95055-SL60	Prisma Filter	8.50 CHF
95055-WB60	Waben Filter	8.50 CHF

Reflektoren

95055-RF60-30	transparent	8.50 CHF
95055-RF60-03	gold	8.50 CHF
95055-RF60-02	schwarz	8.50 CHF



Alle Preise excl. MwSt. und VRG.



59035 – 9.2W Tube Halbeinbaustrahler

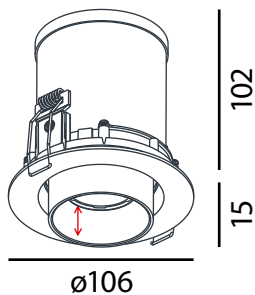

Strom DC **500mA**
(Bitte passenden Konverter dazu bestellen)

Schutzart IP 20

Schutzklasse: III

LED **bridgelux V8**

Leistung 9.2W

Farbwiedergabe Ra 90

Optik Reflektor 48° Schutzglas klar

Dreh- und schwenkbar 355° / 90°

Material Gehäuse Aluminium

Einbau Spreizfedern

Ausschnitt / Einbautiefe AS ø90mm / ET 120mm

Massangaben ø106 × 117mm



2700K **863lm**

3000K **883lm**

59035-27-00	59035-30-00	weiss matt	238.00 CHF
59035-27-12	59035-30-12	weiss matt / schwarz	238.00 CHF
59035-27-02	59035-30-02	schwarz matt	238.00 CHF
59035-27-23	59035-30-23	schwarz / gold	238.00 CHF
59035-27-75	59035-30-75	silberfarbig	238.00 CHF

Zubehör

730051-U	Konverter dim [RC] 500mA 6-12W 115×40×22mm	36.00 CHF
730040	Konverter DALI 20W 111×52×22mm	69.00 CHF
205090	Einbaugehäuse AS ø90mm	52.00 CHF

Filter

95055-SF60	Soft Filter	8.50 CHF
95055-SL60	Prisma Filter	8.50 CHF
95055-WB60	Waben Filter	8.50 CHF

Reflektoren

95055-RF60-30	transparent	8.50 CHF
95055-RF60-03	gold	8.50 CHF
95055-RF60-02	schwarz	8.50 CHF

Alle Preise excl. MwSt. und VRG.

59038 – 2 x 9.2W Tube Halbeinbaustrahler

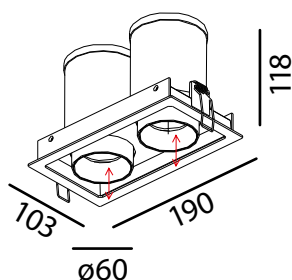

Strom DC	500mA (Bitte passenden Konverter dazu bestellen)
Schutzart	IP 20
Schutzklasse:	III
LED	bridgelux V8
Leistung	2 x 9.2W
Farbwiedergabe Ra	90
Optik	Reflektor 48° Schutzglas klar
Dreh- und schwenkbar	355° / 90°
Material Gehäuse	Aluminium
Einbau	Spreizfedern
Ausschnitt / Einbautiefe	AS 180 x 93mm / ET 125mm
Massangaben	190 x 103 x 118mm



59038-27-00	2700K		2 x 863lm		weiss matt	486.00 CHF
59038-27-12	2700K		2 x 863lm		weiss matt / schwarz	486.00 CHF
59038-30-00	3000K		2 x 883lm		weiss matt	486.00 CHF
59038-30-12	3000K		2 x 883lm		weiss matt / schwarz	486.00 CHF

Zubehör

730051-U	Benötigt 2x	Konverter dim [RC] 500mA 6-12W 115x40x22mm	36.00 CHF
730040		Konverter DALI 20W Leuchten in Serie schalten!	69.00 CHF
310400-180		Einbetonierdose mit Ausschnitt 180 x 93 für 59038	78.00 CHF
300001	Benötigt 2x	Zwischenring 15mm	14.00 CHF

Filter

95055-SF60		Soft Filter	8.50 CHF
95055-SL60		Prisma Filter	8.50 CHF
95055-WB60		Waben Filter	8.50 CHF

Reflektoren

95055-RF60-30		transparent	8.50 CHF
95055-RF60-03		gold	8.50 CHF
95055-RF60-02		schwarz	8.50 CHF



Alle Preise excl. MwSt. und VRG.

59036 – 9.2W Tube Halbeinbaustrahler randlos

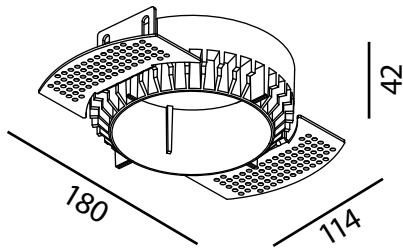

Inklusive Montagerahmen

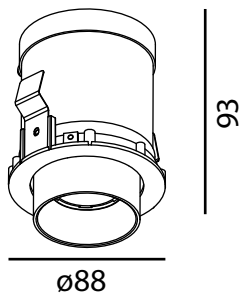

Strom DC	500mA (Bitte passenden Konverter dazu bestellen)
Schutzart	IP 20
Schutzklasse:	III
LED	bridgelux V8
Leistung	9.2W
Farbwiedergabe Ra	90
Optik	Reflektor 48° Schutzglas klar
Dreh- und schwenkbar	355° / 90°
Material Gehäuse	Aluminium
Einbau	Montageplatte
Ausschnitt / Einbautiefe	AS ø130mm / ET 120mm
Massangaben	ø88 × 93mm

59036-27-00	2700K		863lm	<input type="checkbox"/> weiss matt	268.00 CHF
59036-30-00	3000K		883lm	<input type="checkbox"/> weiss matt	268.00 CHF

Zubehör

730051-U	Konverter dim [RC] 500mA 6-12W 115×40×22mm	36.00 CHF
730040	Konverter DALI 20W 111×52×22mm	69.00 CHF
59036-EB	Einbaugehäuse AS ø130mm	98.00 CHF

Filter

95055-SF60	Soft Filter	8.50 CHF
95055-SL60	Prisma Filter	8.50 CHF
95055-WB60	Waben Filter	8.50 CHF

Reflektoren

95055-RF60-30	transparent	8.50 CHF
95055-RF60-03	gold	8.50 CHF
95055-RF60-02	schwarz	8.50 CHF



Alle Preise excl. MwSt. und VRG.



59033 – 2 x 9.2W Tube Halbeinbaustrahler randlos

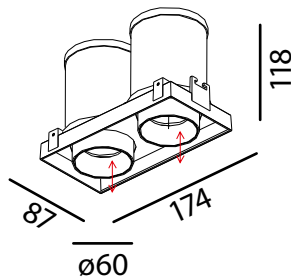
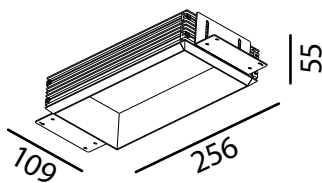

Strom DC **500mA**
(Bitte passenden Konverter dazu bestellen)

Schutzart IP 20

Schutzklasse: III

LED **bridgelux** V8

Leistung 2 x 9.2W

Farbwiedergabe Ra 90

Optik Reflektor 48° Schutzglas klar

Dreh- und schwenkbar 35° / 90°

Material Gehäuse Aluminium

Einbau Montageplatte

Ausschnitt / Einbautiefe AS 198 x 112mm / ET140mm

Massangaben 174 x 87 x 118mm



59033-27-00	2700K		2 x 863lm		weiss matt	565.00 CHF
59033-27-12	2700K		2 x 863lm		weiss matt / schwarz	565.00 CHF
59033-30-00	3000K		2 x 883lm		weiss matt	565.00 CHF
59033-30-12	3000K		2 x 883lm		weiss matt / schwarz	565.00 CHF

Zubehör

730051-U	Benötigt 2x	Konverter dim [RC] 500mA 6-12W 115x40x22mm	36.00 CHF
730040		Konverter DALI 20W Leuchten in Serie schalten!	69.00 CHF
59033-EB		Einbaugeschäse AS 198 x 112mm	98.00 CHF

Filter

95055-SF60		Soft Filter	8.50 CHF
95055-SL60		Prisma Filter	8.50 CHF
95055-WB60		Waben Filter	8.50 CHF

Reflektoren

95055-RF60-30		transparent	8.50 CHF
95055-RF60-03		gold	8.50 CHF
95055-RF60-02		schwarz	8.50 CHF

Alle Preise excl. MwSt. und VRG.



95028 – 9.2W / 13.6W Turn In Halbeinbaustrahler

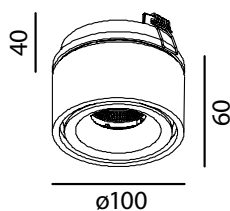

Spannung	500 / 700mA (Bitte passenden Konverter dazu bestellen)
Schutzart	IP 20
Schutzklasse:	III

LED **bridgelux** V8

Leistung	6.2 / 9.2 / 13.6W
Farbwiedergabe Ra	90
Optik	Reflektor 45°
Dreh- und schwenkbar	355° / 90°
Material Gehäuse	Aluminium
Einbau	Spreizfedern
Ausschnitt / Einbautiefe	AS ø90mm / ET 40mm
Massangaben	ø100 × 103mm

		500mA		700mA			
95028-27-00	2700K		863lm		1115lm		weiss matt 148.00 CHF
95028-27-12	2700K		863lm		1115lm		weiss matt / schwarz 148.00 CHF
95028-30-00	3000K		883lm		1141lm		weiss matt 148.00 CHF
95028-30-12	3000K		883lm		1141lm		weiss matt / schwarz 148.00 CHF

Zubehör

730051-U	Konverter dim [RC] 500mA 6-12W 115×40×22mm	36.00 CHF
730040	Konverter DALI 20W 111×52×22mm	69.00 CHF
205090	Einbaugehäuse mit Tank AS ø90mm	52.00 CHF

Alle Preise excl. MwSt. und VRG.

56040 – 9.2W Halbeinbaustrahler

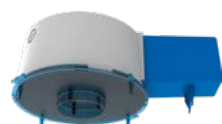
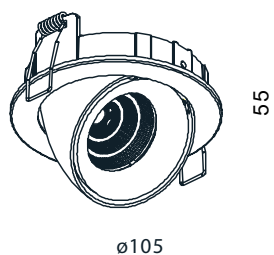

Strom DC	500mA (Bitte passenden Konverter dazu bestellen)
Schutzart	IP 20
Schutzklasse:	III

LED **bridgelux** V8

Leistung	9.2W
Farbwiedergabe Ra	90
Optik	Reflektor 45° Schutzglas klar
Dreh- und schwenkbar	355° / 45°
Material Gehäuse	Aluminium
Einbau	Spreizfedern
Ausschnitt / Einbautiefe	AS ø95mm / ET 70mm
Massangaben	ø105 × 55mm

56040-27-00	2700K		863lm		weiss matt 112.00 CHF
56040-27-02	2700K		863lm		schwarz matt 112.00 CHF
56040-27-75	2700K		863lm		silberfarbig 112.00 CHF
56040-30-00	3000K		883lm		weiss matt 112.00 CHF
56040-30-02	3000K		883lm		schwarz matt 112.00 CHF
56040-30-75	3000K		883lm		silberfarbig 112.00 CHF

Zubehör

730051-U	Konverter dim [RC] 500mA 6-12W 115×40×22mm	36.00 CHF
730040	Konverter DALI 20W 111×52×22mm	69.00 CHF
205095	Einbaugehäuse mit Tank AS ø95mm	52.00 CHF

Alle Preise excl. MwSt. und VRG.

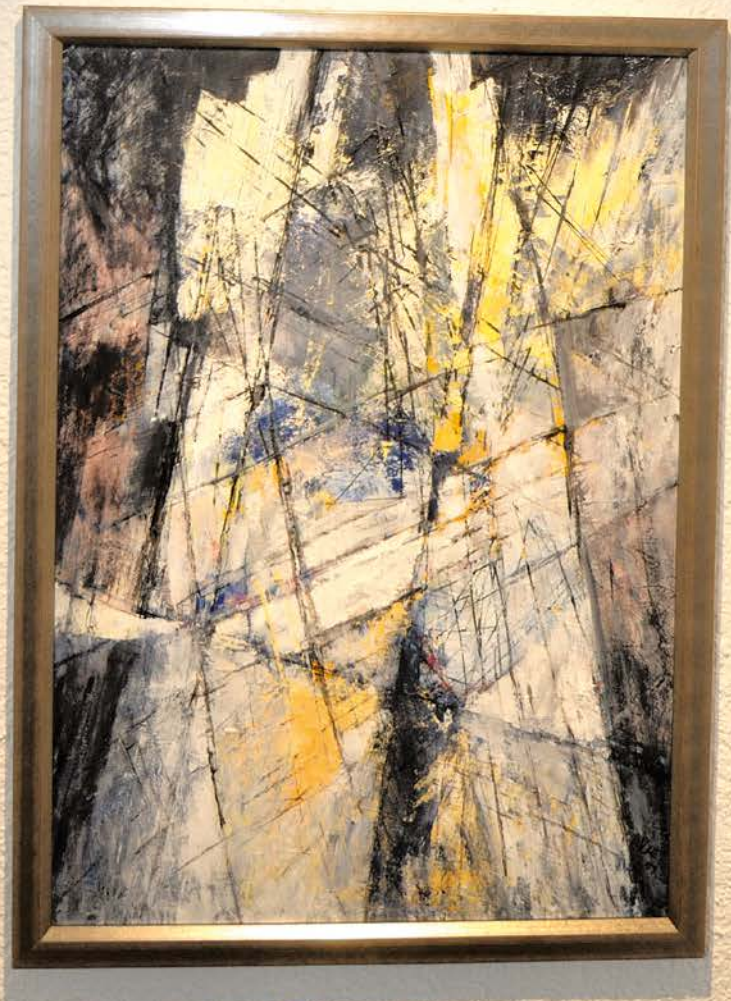

75040 – 12W Halbeinbaustrahler

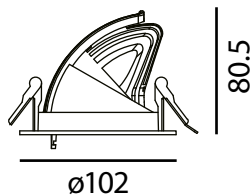

ø102



ø 90

75040-30-00	3000K		1525lm	<input type="checkbox"/> weiss matt	115.00 CHF
75040-40-00	4000K		1619lm	<input type="checkbox"/> weiss matt	115.00 CHF

Zubehör

730050	Konverter dim [RC] 350mA 6-12W 89×44×22mm	36.00 CHF
730040	Konverter DALI 20W 111×52×22mm	69.00 CHF
205090	Einbaugehäuse mit Tank AS ø90mm	52.00 CHF

Alle Preise excl. MwSt. und VRG.



Strom DC	350mA
	(Bitte passenden Konverter dazu bestellen)
Schutzart	IP 20
Schutzklasse:	III
LED	bridgelux V10 Gen 7
Leistung	12W
Farbwiedergabe Ra	90
Optik	Reflektor 36° Schutzglas klar
Dreh- und schwenkbar	355° / 45°
Material Gehäuse	Aluminium
Einbau	Spreizfedern
Ausschnitt / Einbautiefe	AS ø90mm / ET 100mm
Massangaben	ø102 × 80.5mm

75041 – 20W / 30W Halbeinbaustrahler

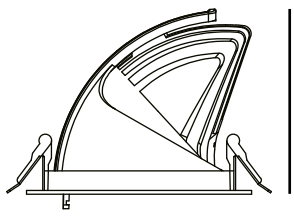

ø140



ø 125

	3000K	500mA	700mA		
75041-30-00		2391lm		3317lm	<input type="checkbox"/> weiss matt 158.00 CHF
75041-40-00		2564lm		3557lm	<input type="checkbox"/> weiss matt 158.00 CHF

Zubehör

730041	Konverter DALI 32W 103×67×21mm	89.00 CHF
205125	Einbaugehäuse mit Tank AS 125mm	52.00 CHF

Alle Preise excl. MwSt. und VRG.



Strom DC	500 / 700mA
	(Bitte passenden Konverter dazu bestellen)
Schutzart	IP 20
Schutzklasse:	III
LED	bridgelux V13
Leistung	20W / 30W
Farbwiedergabe Ra	90
Optik	Reflektor 36° Schutzglas klar
Dreh- und schwenkbar	355° / 45°
Material Gehäuse	Aluminium
Einbau	Spreizfedern
Ausschnitt / Einbautiefe	AS ø125mm / ET 125mm
Massangaben	ø140 × 115mm





126 95035
Linso

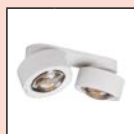

127 95036
Linso



129 95027
Turn out



129 95026
Turn out DALI



131 95040
Mini Tube



133 95042
Mini Tube Line 2

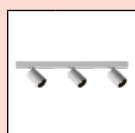

135 95043
Mini Tube Line 3



137 95041
Mini Tube Duo



138 95045
Mini Tube Trio



139 95033



139 95032
Tube



140 95052
Cilindro



141 95053
Quadrato



141 95054
Rettangola

Anbauleuchten 230V



142 95059
Cily



142 95050
Quby



143 63005
Tube Outdoor



143 63006
Quby Outdoor



144 95051
Cubbo

95035 – 12.2W Linso LED Anbaustrahler

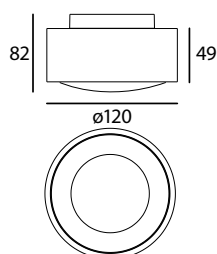

Spannung	220-240V AC, 50Hz (inkl. 350mA Konverter / dimmbar)
Schutzart	IP 20
Schutzklasse:	I
LED	bridgelux V10c
Leistung	12.2W
Farbwiedergabe Ra	90
Optik	Reflektor 48°
Dreh- und schwenkbar	355° / 90°
Material Gehäuse	Aluminium
Aufbau	Montageplatte
Massangaben	ø120 × 82mm

New	95035-27-00	2700K	A E	1462lm	weiss matt	264.00 CHF
New	95035-27-02	2700K	A E	1462lm	schwarz matt	264.00 CHF
New	95035-30-00	3000K	A D	1531lm	weiss matt	264.00 CHF
New	95035-30-02	3000K	A D	1531lm	schwarz matt	264.00 CHF

Reflektoren

95035-RF22	22° Reflektor für Lens Anbaustrahler	9.50 CHF
95035-RF36	36° Reflektor für Lens Anbaustrahler	9.50 CHF

Alle Preise excl. MwSt. und VRG.

95035 – 11.8W Linso DTW LED Anbaustrahler

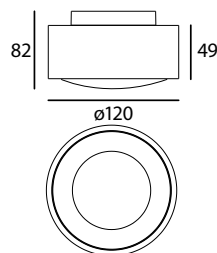
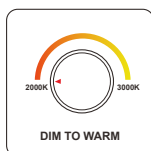

Spannung	220-240V AC, 50Hz (inkl. 350mA Konverter / dimmbar)
Schutzart	IP 20
Schutzklasse:	I
LED	bridgelux V10c
Leistung	11.8W
Farbwiedergabe Ra	90
Optik	Reflektor 48°
Dreh- und schwenkbar	355° / 90°
Material Gehäuse	Aluminium
Aufbau	Montageplatte
Massangaben	ø120 × 82mm

Dim to Warm Funktion nur mit einem PhasenAbschnitt Dimmer möglich, z.B. Feller LED Universaldimmer 40200.LED

New	95035-50-00	1800–3000K	A F	1037lm	weiss matt	284.00 CHF
New	95035-50-02	1800–3000K	A F	1037lm	schwarz matt	284.00 CHF

Reflektoren

95035-RF28	28° Reflektor für Lens DTW Anbaustrahler	9.50 CHF
95035-RF38	38° Reflektor für Lens DTW Anbaustrahler	9.50 CHF

Alle Preise excl. MwSt. und VRG.

95036 – 2 × 12.2W Linso LED Anbaustrahler



Spannung 220-240V AC, 50Hz
(inkl. 350mA Konverter / dimmbar)

Schutzart IP 20

Schutzklasse: I

LED **bridgelux** V10c

Leistung 2 × 12.2W

Farbwiedergabe Ra 90

Optik Reflektor 48°

Dreh- und schwenkbar 355° / 90°

Material Gehäuse Aluminium

Aufbau Montageplatte

Massangaben ø120 × 82mm

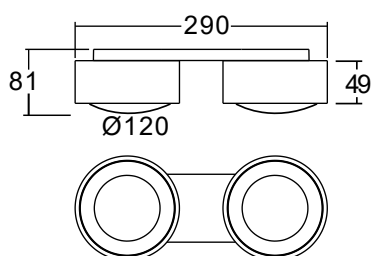

New	95036-27-00	2700K		2 × 1462lm	<input type="checkbox"/> weiss matt	526.00 CHF
New	95036-27-02	2700K		2 × 1462lm	<input checked="" type="checkbox"/> schwarz matt	526.00 CHF
New	95036-30-00	3000K		2 × 1531lm	<input type="checkbox"/> weiss matt	526.00 CHF
New	95036-30-02	3000K		2 × 1531lm	<input checked="" type="checkbox"/> schwarz matt	526.00 CHF

Reflektoren

95036-RF22	22° Reflektor für Linso Anbaustrahler	CHF
95036-RF36	36° Reflektor für Linso Anbaustrahler	CHF

Alle Preise excl. MwSt. und VRG.

95036 – 2 × 11.8W Linso DTW LED Anbaustrahler



Spannung 220-240V AC, 50Hz
(inkl. 350mA Konverter / dimmbar)

Schutzart IP 20

Schutzklasse: I

LED **bridgelux** V10c

Leistung 2 × 11.8W

Farbwiedergabe Ra 90

Optik Reflektor 48°

Dreh- und schwenkbar 355° / 90°

Material Gehäuse Aluminium

Aufbau Montageplatte

Massangaben ø120 × 82mm

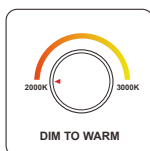

Dim to Warm Funktion nur mit einem PhasenABSchnitt Dimmer möglich, z.B. Feller LED Universaldimmer 40200.LED

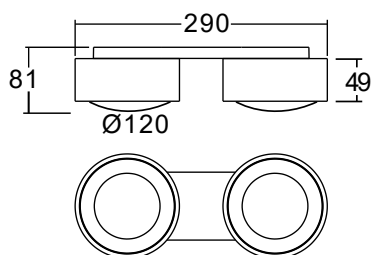

New	95036-50-00	1800–3000K		2 × 1037lm	<input type="checkbox"/> weiss matt	526.00 CHF
New	95036-50-02	1800–3000K		2 × 1037lm	<input checked="" type="checkbox"/> schwarz matt	526.00 CHF

Reflektoren

95036-RF28	28° Reflektor für Lens DTW Anbaustrahler	CHF
95036-RF38	38° Reflektor für Lens DTW Anbaustrahler	CHF

Alle Preise excl. MwSt. und VRG.



95027 – 9.3W Turn out LED Anbaustrahler

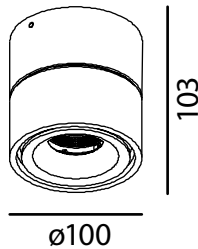
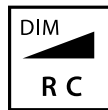

Spannung	220-240V AC, 50Hz (inkl. 500mA Konverter / dimmbar)
Schutzart	IP 20
Schutzklasse:	I
LED	bridgelux. V8
Leistung	9.3W
Farbwiedergabe Ra	80
Optik	Reflektor 45°
Dreh- und schwenkbar	355° / 90°
Material Gehäuse	Aluminium
Aufbau	Montageplatte
Massangaben	ø100 × 103mm

	95027-27-00	2700K	AG F	835lm		weiss matt	274.00 CHF
	95027-27-12	2700K	AG F	835lm		weiss / schwarz	274.00 CHF
New	95027-27-02	2700K	AG F	835lm		schwarz matt	274.00 CHF
New	95027-27-23	2700K	AG F	835lm		schwarz / gold	274.00 CHF
	95027-30-00	3000K	AG F	870lm		weiss matt	274.00 CHF
	95027-30-12	3000K	AG F	870lm		weiss / schwarz	274.00 CHF
New	95027-30-02	3000K	AG F	870lm		schwarz matt	274.00 CHF

Alle Preise excl. MwSt. und VRG.

95026 – 9.3W Turn out LED Anbaustrahler

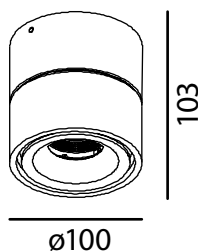
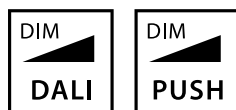

Spannung	220-240V AC, 50Hz (inkl. 500mA Konverter / dimmbar)
Schutzart	IP 20
Schutzklasse:	I
LED	bridgelux. V8
Leistung	9.3W
Farbwiedergabe Ra	80
Optik	Reflektor 45°
Dreh- und schwenkbar	355° / 90°
Aufbau	Montageplatte
Material Gehäuse	Aluminium
Massangaben	ø100 × 103mm

	95026-27-00	2700K	AG F	835lm		weiss matt	318.00 CHF
	95026-27-12	2700K	AG F	835lm		weiss / schwarz	318.00 CHF
	95026-30-00	3000K	AG F	870lm		weiss matt	318.00 CHF
	95026-30-12	3000K	AG F	870lm		weiss / schwarz	318.00 CHF

Alle Preise excl. MwSt. und VRG.



95040 – 9.2W Mini Tube LED Anbaustrahler

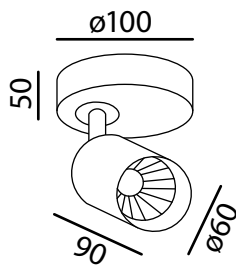

Spannung	220-240V AC, 50Hz (inkl. 500mA Konverter / dimmbar)
Schutzart	IP 20
Schutzklasse:	I
LED	bridgelux V8
Leistung	9.2W
Farbwiedergabe Ra	90
Optik	Reflektor 45° Schutzglas klar
Dreh- und schwenkbar	355° / 90°
Material Gehäuse	Aluminium
Anbau	Montageplatte
Massangaben	ø100 × 157mm



Phasenabschnitt dimmbar mit
Feller LED Universaldimmer
40200.LED

95040-27-00	2700K		863lm		weiss matt	182.00 CHF
95040-27-02	2700K		863lm		schwarz matt*	182.00 CHF
95040-27-75	2700K		863lm		silberfarbig	182.00 CHF
95040-30-00	3000K		883lm		weiss matt	182.00 CHF
95040-30-02	3000K		883lm		schwarz matt*	182.00 CHF
95040-30-75	3000K		883lm		silberfarbig	182.00 CHF

Filter

95055-SF60		Soft Filter	8.50 CHF
95055-SL60		Prisma Filter	8.50 CHF
95055-WB60		Waben Filter	8.50 CHF

Reflektoren

95055-RF60-30		transparent	8.50 CHF
95055-RF60-03		gold	8.50 CHF
95055-RF60-02		schwarz	8.50 CHF

Alle Preise excl. MwSt. und VRG.



95042 – 2 × 9.2W Mini Tube Line 2 LED Anbaustrahler

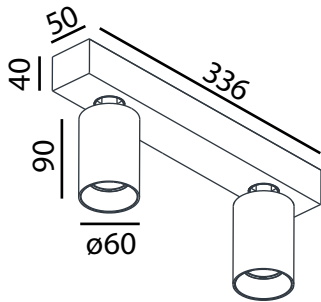

Spannung	220-240V AC, 50Hz (inkl. 500mA Konverter / dimmbar)
Schutzart	IP 20
Schutzklasse:	I
LED	bridgelux V8
Leistung	2 × 9.2W
Farbwiedergabe Ra	90
Optik	Reflektor 45° Schutzglas klar
Dreh- und schwenkbar	35° / 90°
Material Gehäuse	Aluminium
Anbau	Montageplatte
Massangaben	336 × 60 × 148mm



Phasenabschnitt dimmbar mit
Feller LED Universaldimmer
40200.LED

95042-27-00	2700K		2 × 863lm		weiss matt	292.00 CHF
95042-27-02	2700K		2 × 863lm		schwarz matt *	292.00 CHF
95042-27-75	2700K		2 × 863lm		silberfarbig	292.00 CHF
95042-30-00	3000K		2 × 883lm		weiss matt	292.00 CHF
95042-30-02	3000K		2 × 883lm		schwarz matt *	292.00 CHF
95042-30-75	3000K		2 × 883lm		silberfarbig	292.00 CHF

Filter

95055-SF60		Soft Filter	8.50 CHF
95055-SL60		Prisma Filter	8.50 CHF
95055-WB60		Waben Filter	8.50 CHF

Reflektoren

95055-RF60-30		transparent	8.50 CHF
95055-RF60-03		gold	8.50 CHF
95055-RF60-02		schwarz	8.50 CHF

Alle Preise excl. MwSt. und VRG.



95043 – 3 × 9.2W Mini Tube Line 3 LED Anbaustrahler

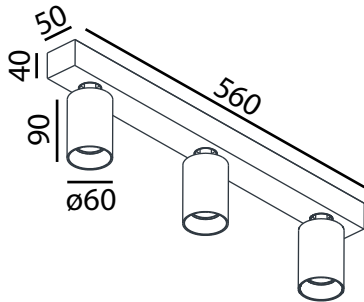

Spannung	220-240V AC, 50Hz (inkl. 500mA Konverter / dimmbar)
Schutzart	IP 20
Schutzklasse:	I
LED	bridgelux V8
Leistung	3 × 9.2W
Farbwiedergabe Ra	90
Optik	Reflektor 45° Schutzglas klar
Dreh- und schwenkbar	355° / 90°
Material Gehäuse	Aluminium
Anbau	Montageplatte
Massangaben	560 × 60 × 148mm



Phasenabschnitt dimmbar mit
Feller LED Universaldimmer
40200.LED

95043-27-00	2700K		3 × 863lm	<input type="checkbox"/> weiss matt	422.00 CHF
95043-27-02	2700K		3 × 863lm	<input checked="" type="checkbox"/> schwarz matt *	422.00 CHF
95043-27-75	2700K		3 × 863lm	<input type="checkbox"/> silberfarbig	422.00 CHF
95043-30-00	3000K		3 × 883lm	<input type="checkbox"/> weiss matt	422.00 CHF
95043-30-02	3000K		3 × 883lm	<input checked="" type="checkbox"/> schwarz matt *	422.00 CHF
95043-30-75	3000K		3 × 883lm	<input type="checkbox"/> silberfarbig	422.00 CHF

Filter



95055-SF60		Soft Filter	8.50 CHF
95055-SL60		Prisma Filter	8.50 CHF
95055-WB60		Waben Filter	8.50 CHF



Reflektoren

95055-RF60-30		transparent	8.50 CHF
95055-RF60-03		gold	8.50 CHF
95055-RF60-02		schwarz	8.50 CHF

Alle Preise excl. MwSt. und VRG.



95041 – 2 × 9.2W Mini Tube Duo LED Anbaustrahler

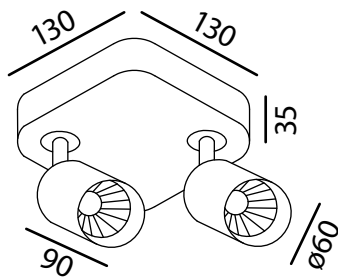

Spannung	220-240V AC, 50Hz (inkl. 500mA Konverter / dimmbar)
Schutzart	IP 20
Schutzklasse:	I
LED	bridgelux V8
Leistung	2 × 9.2W
Farbwiedergabe Ra	90
Optik	Reflektor 45° Schutzglas klar
Dreh- und schwenkbar	35° / 90°
Material Gehäuse	Aluminium
Anbau	Montageplatte
Massangaben	130 × 130 × 157mm

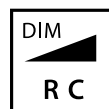

Phasenabschnitt dimmbar mit
Feller LED Universaldimmer
40200.LED

95041-27-00	2700K		2 × 863lm		weiss matt	292.00 CHF
95041-27-02	2700K		2 × 863lm		schwarz matt *	292.00 CHF
95041-27-75	2700K		2 × 863lm		silberfarbig	292.00 CHF
95041-30-00	3000K		2 × 883lm		weiss matt	292.00 CHF
95041-30-02	3000K		2 × 883lm		schwarz matt *	292.00 CHF
95041-30-75	3000K		2 × 883lm		silberfarbig	292.00 CHF

Filter



95055-SF60		Soft Filter	8.50 CHF
95055-SL60		Prisma Filter	8.50 CHF
95055-WB60		Waben Filter	8.50 CHF

Reflektoren



95055-RF60-30		transparent	8.50 CHF
95055-RF60-03		gold	8.50 CHF
95055-RF60-02		schwarz	8.50 CHF

Alle Preise excl. MwSt. und VRG.

95045 – 3 × 9.2W Mini Tube Trio LED Anbaustrahler



Spannung	220-240V AC, 50Hz (inkl. 500mA Konverter / dimmbar)
Schutzart	IP 20
Schutzklasse:	I
LED	bridgelux V8
Leistung	3 × 9.2W
Farbwiedergabe Ra	90
Optik	Reflektor 45° Schutzglas klar
Dreh- und schwenkbar	355° / 90°
Material Gehäuse	Aluminium
Anbau	Montageplatte
Massangaben	ø250 × 157mm

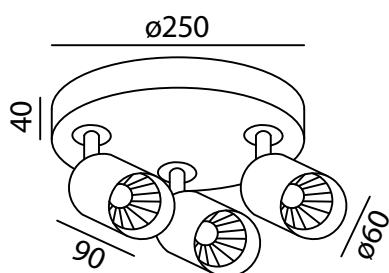

Phasenabschnitt dimmbar mit
Feller LED Universaldimmer
40200.LED

95045-27-00	2700K	AG F	3 × 863lm	weiss matt	422.00 CHF
95045-27-02	2700K	AG F	3 × 863lm	schwarz matt *	422.00 CHF
95045-27-75	2700K	AG F	3 × 863lm	silberfarbig	422.00 CHF
95045-30-00	3000K	AG F	3 × 883lm	weiss matt	422.00 CHF
95045-30-02	3000K	AG F	3 × 883lm	schwarz matt *	422.00 CHF
95045-30-75	3000K	AG F	3 × 883lm	silberfarbig	422.00 CHF

Filter



95055-SF60	t	Soft Filter	8.50 CHF
95055-SL60	t	Prisma Filter	8.50 CHF
95055-WB60	■	Waben Filter	8.50 CHF

Reflektoren



95055-RF60-30	t	transparent	8.50 CHF
95055-RF60-03	■	gold	8.50 CHF
95055-RF60-02	■	schwarz	8.50 CHF

Alle Preise excl. MwSt. und VRG.

95033 – 9.2W Aufbaustrahler

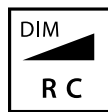
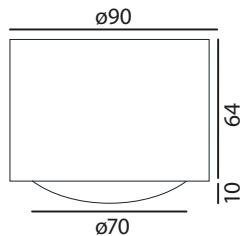

Phasenabschnitt dimmbar mit
Feller LED Universaldimmer
40200.LED

95033-27-00	2700K	863lm	weiss matt	238.00 CHF
95033-27-02	2700K	863lm	schwarz matt	238.00 CHF
95033-30-00	3000K	883lm	weiss matt	238.00 CHF
95033-30-02	3000K	883lm	schwarz matt	238.00 CHF

Alle Preise excl. MwSt. und VRG.



Spannung	220-240V AC, 50Hz (inkl. 500mA Konverter / dimmbar)
Schutzart	IP 54
Schutzklasse:	I
LED	bridgelux V8
Leistung	9.2W
Farbwiedergabe Ra	90
Optik	Linse 32°
Material Gehäuse	Aluminium
Einbau	Direkt geschraubt
Massangaben	ø90 × 74mm

95032 – 9.3W Tube LED Anbaustrahler

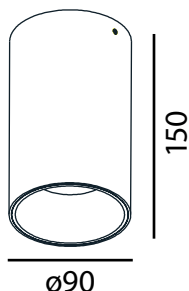

Phasenabschnitt dimmbar mit
Feller LED Universaldimmer
40200.LED

95032-27-00	2700K	956lm	weiss matt	198.00 CHF
95032-27-02	2700K	956lm	schwarz matt	198.00 CHF
95032-27-75	2700K	956lm	silberfarbig	198.00 CHF
95032-30-00	3000K	1003lm	weiss matt	198.00 CHF
95032-30-02	3000K	1003lm	schwarz matt	198.00 CHF
95032-30-75	3000K	1003lm	silberfarbig	198.00 CHF

Alle Preise excl. MwSt. und VRG.



Spannung	220-240V AC, 50Hz (inkl. 350mA Konverter / dimmbar)
Schutzart	IP 20
Schutzklasse:	I
LED	bridgelux V10
Leistung	9.3W
Farbwiedergabe Ra	90
Optik	Reflektor 50° Schutzglas klar
Material Gehäuse	Aluminium
Anbau	Montagplatte
Massangaben	ø90 × 150mm



95052 – 12W Cilindro LED Anbaustrahler

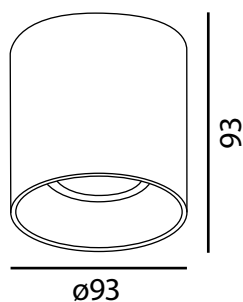

Spannung	220-240V AC, 50Hz (inkl. 300mA Konverter / dimmbar)
Schutzart	IP 20
Schutzklasse:	I
LED	CITIZEN CLU028
Leistung	11.4W
Farbwiedergabe Ra	90
Optik	Linse 36°
Material Gehäuse	Alu-Druckguss
Massangaben	ø93 × 93mm



Phasenabschnitt dimmbar mit
Feller LED Universaldimmer
40200.LED



95052-27-00	2700K	A A G	F	1139lm		weiss matt	218.00 CHF
95052-27-02	2700K	A A G	F	1139lm		schwarz matt	218.00 CHF
95052-27-23	2700K	A A G	F	1139lm		schwarz gold	238.00 CHF
95052-27-18	2700K	A A G	F	1139lm		champagner	218.00 CHF
95052-27-28	2700K	A A G	F	1139lm		rosegold	218.00 CHF
95052-30-00	3000K	A A G	E	1266lm		weiss matt	218.00 CHF
95052-30-02	3000K	A A G	E	1266lm		schwarz matt	218.00 CHF
95052-30-23	3000K	A A G	E	1266lm		schwarz gold	238.00 CHF
95052-30-75	3000K	A A G	E	1266lm		silberfarbig	218.00 CHF

Alle Preise excl. MwSt. und VRG.

95053 – 12W Quadrato LED Anbaustrahler



Spannung	220-240V AC, 50Hz (inkl. 350mA Konverter / dimmbar)
Schutzart	IP 20
Schutzklasse:	LED CITIZEN CLU028
Leistung	11.4W
Farbwiedergabe Ra	90
Optik	Linse
Material Gehäuse	Alu-Druckguss
Massangaben	93 × 93 × 93mm



Phasenabschnitt dimmbar mit
Feller LED Universaldimmer
40200.LED

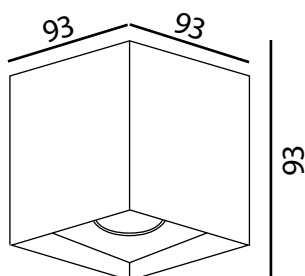

95053-27-00	2700K		1139lm		weiss matt	228.00 CHF
95053-27-02	2700K		1139lm		schwarz matt	228.00 CHF
95053-27-23	2700K		1139lm		schwarz gold	234.00 CHF
95053-27-75	2700K		1139lm		silberfarbig	228.00 CHF
95053-30-00	3000K		1266lm		weiss matt	228.00 CHF
95053-30-02	3000K		1266lm		schwarz matt	228.00 CHF
95053-30-23	3000K		1266lm		schwarz gold	234.00 CHF
95053-30-75	3000K		1266lm		silberfarbig	228.00 CHF

Alle Preise excl. MwSt. und VRG.

95054 – 2 × 12W Rettangolo LED Anbaustrahler



Spannung	220-240V AC, 50Hz (inkl. 350mA Konverter / dimmbar)
Schutzart	IP 20
Schutzklasse:	LED CITIZEN CLU028
Leistung	2 × 11.4W
Farbwiedergabe Ra	90
Optik	Linse
Material Gehäuse	Alu-Druckguss
Massangaben	93 × 93 × 186mm



Phasenabschnitt dimmbar mit
Feller LED Universaldimmer
40200.LED

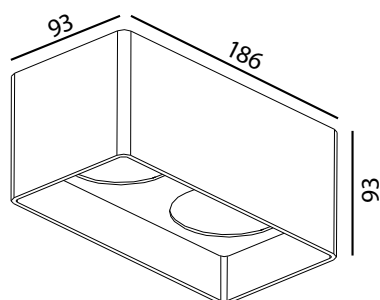

95054-27-00	2700K		2 × 1139lm		weiss matt	368.00 CHF
95054-27-02	2700K		2 × 1139lm		schwarz matt	368.00 CHF
95054-27-23	2700K		2 × 1139lm		schwarz gold	378.00 CHF
95054-27-75	2700K		2 × 1139lm		silberfarbig	368.00 CHF
95054-30-00	3000K		2 × 1266lm		weiss matt	368.00 CHF
95054-30-02	3000K		2 × 1266lm		schwarz matt	368.00 CHF
95054-30-23	3000K		2 × 1266lm		schwarz gold	378.00 CHF
95054-30-75	3000K		2 × 1266lm		silberfarbig	368.00 CHF

Alle Preise excl. MwSt. und VRG.

95059 – 8.9W Cily LED Anbaustrahler



Spannung	220-240V AC, 50Hz (inkl. 500mA Konverter / dimmbar)
Schutzart	IP 20
Schutzklasse:	I
LED	bridgelux V8
Leistung	8.9W
Farbwiedergabe Ra	90
Optik	Reflektor 33° Schutzglas klar
Material Gehäuse	Aluminium
Anbau	Direkt geschraubt
Massangaben	ø85 × 93mm



Phasenabschnitt dimmbar mit
Feller LED Universaldimmer
40200.LED

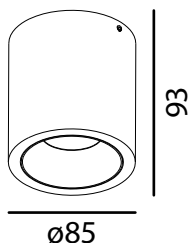

New	95059-27-00	2700K	AG F	863lm		weiss matt	174.00 CHF
New	95059-27-02	2700K	AG F	863lm		schwarz matt	174.00 CHF
New	95059-27-23	2700K	AG F	863lm		schwarz gold	174.00 CHF
New	95059-27-75	2700K	AG F	863lm		silberfarbig	174.00 CHF
New	95059-30-00	3000K	AG F	883lm		weiss matt	174.00 CHF
New	95059-30-02	3000K	AG F	883lm		schwarz matt	174.00 CHF
New	95059-30-23	3000K	AG F	883lm		schwarz gold	174.00 CHF
New	95059-30-75	3000K	AG F	883lm		silberfarbig	174.00 CHF

Alle Preise excl. MwSt. und VRG.

95050 – 9.2W Quby LED Anbaustrahler



Spannung	220-240V AC, 50Hz (inkl. 500mA Konverter / dimmbar)
Schutzart	IP 20
Schutzklasse:	I
LED	bridgelux V8
Leistung	9.2W
Farbwiedergabe Ra	90
Optik	Reflektor 33° Schutzglas klar
Material Gehäuse	Aluminium
Anbau	Direkt geschraubt
Massangaben	85 × 85 × 93mm



Phasenabschnitt dimmbar mit
Feller LED Universaldimmer
40200.LED

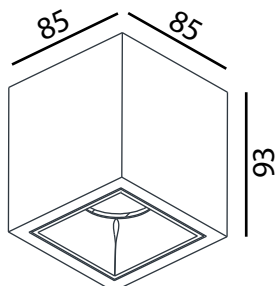

New	95050-27-00	2700K	AG F	863lm		weiss matt	174.00 CHF
New	95050-27-23	2700K	AG F	863lm		schwarz gold	174.00 CHF
New	95050-27-75	2700K	AG F	863lm		silberfarbig	174.00 CHF
New	95050-27-85	2700K	AG F	863lm		dunkelgrau	174.00 CHF
New	95050-30-00	3000K	AG F	883lm		weiss matt	174.00 CHF
New	95050-30-75	3000K	AG F	883lm		silberfarbig	174.00 CHF
New	95050-30-85	3000K	AG F	883lm		dunkelgrau	174.00 CHF

Alle Preise excl. MwSt. und VRG.

63005 – 9.2W Tube Outdoor LED Anbaustrahler IP65

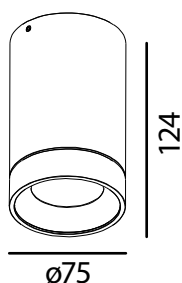

Spannung	220-240V AC, 50Hz (inkl. 500mA Konverter / dimmbar)
Schutzart	IP 65
Schutzklasse:	I
LED	bridgelux V8
Leistung	9.2W
Farbwiedergabe Ra	90
Optik	Reflektor 36° Schutzglas klar
Material Gehäuse	Aluminium
Anbau	Montageplatte
Massangaben	ø75 × 124mm



Phasenabschnitt dimmbar mit
Feller LED Universaldimmer
40200.LED

63005-27-00	2700K		863lm		weiss matt	218.00 CHF
63005-27-02	2700K		863lm		schwarz matt	218.00 CHF
63005-27-75	2700K		863lm		silberfarbig	218.00 CHF
63005-30-00	3000K		883lm		weiss matt	218.00 CHF
63005-30-02	3000K		883lm		schwarz matt	218.00 CHF
63005-30-75	3000K		883lm		silberfarbig	218.00 CHF

Alle Preise excl. MwSt. und VRG.

63006 – 9.2W Quby Outdoor LED Anbaustrahler IP65

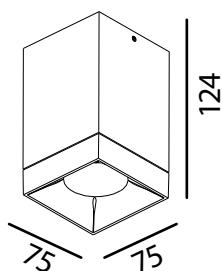

Spannung	220-240V AC, 50Hz (inkl. 500mA Konverter / dimmbar)
Schutzart	IP 65
Schutzklasse:	I
LED	bridgelux V8
Leistung	9.2W
Farbwiedergabe Ra	90
Optik	Reflektor 36° Schutzglas klar
Material Gehäuse	Aluminium
Anbau	Montageplatte
Massangaben	75 × 75 × 124mm



Phasenabschnitt dimmbar mit
Feller LED Universaldimmer
40200.LED

63006-27-00	2700K		863lm		weiss matt	248.00 CHF
63006-27-02	2700K		863lm		schwarz matt	248.00 CHF
63006-27-75	2700K		863lm		silberfarbig	248.00 CHF
63006-30-00	3000K		883lm		weiss matt	248.00 CHF
63006-30-02	3000K		883lm		schwarz matt	248.00 CHF
63006-30-75	3000K		883lm		silberfarbig	248.00 CHF

Alle Preise excl. MwSt. und VRG.

95051 – 9.3W Cubbo LED Anbaustrahler

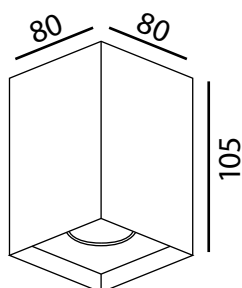

Spannung	220-240V AC, 50Hz (inkl. 350mA Konverter / dimmbar)
Schutzart	IP 20
Schutzklasse:	I

LED **bridgelux** V10

Leistung	9.3W
Farbwiedergabe Ra	90
Optik	Reflektor 35° (12° / 24° auf Anfrage) Schutzglas klar
Material Gehäuse	Aluminium
Anbau	Montagebügel
Massangaben	80 × 80 × 105mm



Phasenabschnitt dimmbar mit
Feller LED Universaldimmer
40200.LED

95051-27-00	2700K	A++ E	956lm	weiss matt	182.00 CHF
95051-27-02	2700K	A++ E	956lm	schwarz matt	182.00 CHF
95051-27-75	2700K	A++ E	956lm	silberfarbig	182.00 CHF
95051-30-00	3000K	A++ E	1003lm	weiss matt	182.00 CHF
95051-30-02	3000K	A++ E	1003lm	schwarz matt	182.00 CHF
95051-30-75	3000K	A++ E	1003lm	silberfarbig	182.00 CHF

Alle Preise excl. MwSt. und VRG.







149 95061

Tube 60



150 95062

Tube 60 Pro



151 95060

Tube 40

Pendelleuchten 230V



95061 – 9.2W Tube 60 LED Pendelleuchte

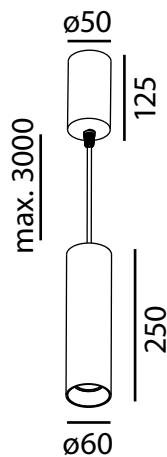

Spannung	220-240V AC, 50Hz (inkl. 500mA Konverter / dimmbar / im Leuchtenkörper)
Schutzart	IP 20
Schutzklasse:	I
LED	bridgelux. V8
Leistung	9.2W
Farbwiedergabe Ra	90
Optik	Reflektor 43° Schutzglas klar
Material Gehäuse	Aluminium
Massangaben Leuchte	ø60 × 250mm
Baldachin	ø50 × 125mm

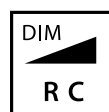

Phasenabschnitt dimmbar mit
Feller LED Universaldimmer
40200.LED

				Kabel (max. 3m)		
95061-27-00	2700K		863lm			248.00 CHF
95061-27-02	2700K		863lm			248.00 CHF
95061-27-75	2700K		863lm			248.00 CHF
95061-30-00	3000K		883lm			248.00 CHF
95061-30-02	3000K		883lm			248.00 CHF
95061-30-75	3000K		883lm			248.00 CHF

Reflektoren

95055-RF60-30		transparent	8.50 CHF
95055-RF60-03		gold	8.50 CHF
95055-RF60-02		schwarz	8.50 CHF

Alle Preise excl. MwSt. und VRG.

95062 – 9.2W Tube 60 Pro LED Pendelleuchte

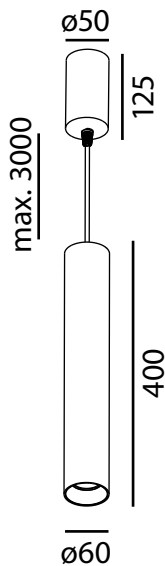

Spannung	220-240V AC, 50Hz (inkl. 500mA Konverter / dimmbar / im Leuchtenkörper)
Schutzart	IP 20
Schutzklasse:	I
LED	bridgelux V8
Leistung	9.2W
Farbwiedergabe Ra	90
Optik	Reflektor 43° Schutzglas klar
Material Gehäuse	Aluminium
Massangaben Leuchte	ø60 × 400mm
Baldachin	ø50 × 125mm



Phasenabschnitt dimmbar mit
Feller LED Universaldimmer
40200.LED

						Kabel (max. 3m)	
New	95062-27-00	2700K	A G F	863lm	weiss matt	transparent	268.00 CHF
New	95062-27-02	2700K	A G F	863lm	schwarz matt *	schwarz	268.00 CHF
New	95062-27-03	2700K	A G F	863lm	gold	schwarz	268.00 CHF
New	95062-27-75	2700K	A G F	863lm	silberfarbig	schwarz	268.00 CHF
New	95062-30-00	3000K	A G F	883lm	weiss matt	transparent	268.00 CHF
New	95062-30-02	3000K	A G F	883lm	schwarz matt *	schwarz	268.00 CHF
New	95062-30-03	3000K	A G F	883lm	gold	schwarz	268.00 CHF
New	95062-30-75	3000K	A G F	883lm	silberfarbig	schwarz	268.00 CHF

Reflektoren

95055-RF60-30	transparent	8.50 CHF
95055-RF60-03	gold	8.50 CHF
95055-RF60-02	schwarz	8.50 CHF

Alle Preise excl. MwSt. und VRG.

95060 – 6.2W Tube 40 LED Pendelleuchte

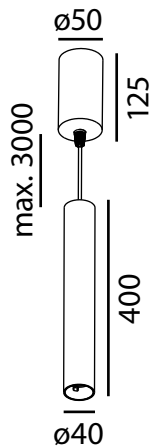

Spannung	220-240V AC, 50Hz (inkl. 350mA Konverter / dimmbar / im Baldachin)
Schutzart	IP 20
Schutzklasse:	I
LED	bridgelux V8
Leistung	6.2W
Farbwiedergabe Ra	90
Optik	Reflektor 35° Schutzglas klar
Material Gehäuse	Aluminium
Massangaben Leuchte	ø40 × 400mm
Baldachin	ø50 × 125mm



Phasenabschnitt dimmbar mit
Feller LED Universaldimmer
40200.LED

				Kabel (max. 3m)				
95060-27-00	2700K		642lm		weiss matt		transparent	218.00 CHF
95060-27-02	2700K		642lm		schwarz matt		schwarz	218.00 CHF
95060-27-75	2700K		642lm		silberfarbig		schwarz	218.00 CHF
95060-30-00	3000K		657lm		weiss matt		transparent	218.00 CHF
95060-30-02	3000K		657lm		schwarz matt		schwarz	218.00 CHF
95060-30-75	3000K		657lm		silberfarbig		schwarz	218.00 CHF

Reflektoren

95055-RF40-30		transparent	8.50 CHF
95055-RF40-03		gold	8.50 CHF
95055-RF40-02		schwarz	8.50 CHF

Alle Preise excl. MwSt. und VRG.





154 95057

Twist Track



155 95030

Turn Track 9.3W

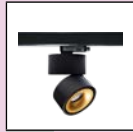

155 95031

Turn Track 13.8W



157 95055

Tube Track HV



159 30030

Tube Track GU10



160 95056

Tube 60 Track



161 95056

Tube 60 Track DTW



162 95056

Tube 60 PRO



163 95056

Tube 60 PRO DALI



164 95048

Tube Track

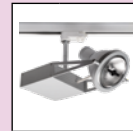

165 95038

Sat 15W



166 30020

Opus



166 30021

Domino



166 30022

Conos



167 20023

Zeno



167 3024

Focus



167 3025

Cano



168

Anbaugehäuse



170 1 Phase

Aufbau

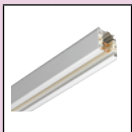

172 3 Phasen

Aufbau

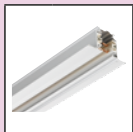

172 3 Phasen

Einbau

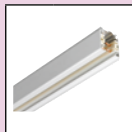

174 3 Phasen

Aufbau DALI

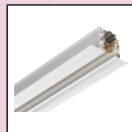

175 3 Phasen

Einbau DALI

Schienenstrahler



95057 – 9.4W Twist Track LED Schienenstrahler Dim to Warm



Inklusive GLOBAL
3-Phasen Adapter

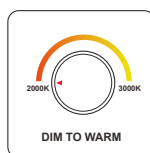

Spannung	220-240V AC, 50Hz (inkl. 500mA Konverter / dimmbar)	
Schutzart	IP 20	
Schutzklasse:	I	
LED	Prolight	PDSQ-10VFL (DTW)
Optio		
Leistung	9.4W	
Farbwiedergabe Ra	90	
Optik	Reflektor 48° (24° / 34° auf Anfrage)	
Dreh- und schwenkbar	355° / 90°	
Massangaben	ø65 x 200mm	

Dim to Warm Funktion nur mit einem
PhasenABSchnitt Dimmer möglich, z.B.
Feller LED Universaldimmer 40200.LED

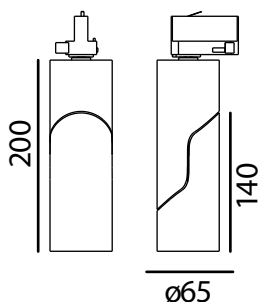

95057-50-00	2000-3000K	LED F	919lm	weiss matt	248.00 CHF
95057-50-23	2000-3000K	LED F	919lm	schwarz/gold	248.00 CHF
95057-50-75	2000-3000K	LED F	919lm	silberfarbig	248.00 CHF

Filter		
95055-SF60	Soft Filter	8.50 CHF
95055-SL60	Prisma Filter	8.50 CHF
95055-WB60	Waben Filter	8.50 CHF

Alle Preise excl. MwSt. und VRG.

95030 – 9.3W Turn Track Schienenstrahler



Inklusive GLOBAL
3-Phasen Adapter



Spannung 220-240V AC, 50Hz
(inkl. 500mA Konverter / dimmbar)

Schutzart IP 20
Schutzklasse: I

LED **bridgelux** V8

Leistung 9.3W

Farbwiedergabe Ra 80

Optik Reflektor 45°

Dreh- und schwenkbar 355° / 90°

Material Gehäuse Aluminium

Massangaben ø100 × 103mm



Phasenabschnitt dimmbar mit
Feller LED Universaldimmer
40200.LED

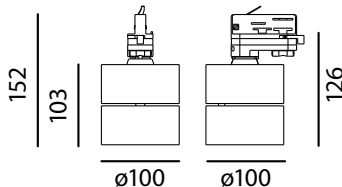

95030-27-00	2700K		835lm		weiss matt	289.00 CHF
95030-27-12	2700K		835lm		weiss / schwarz	289.00 CHF
95030-30-00	3000K		870lm		weiss matt	289.00 CHF
95030-30-12	3000K		870lm		weiss / schwarz	289.00 CHF

Alle Preise excl. MwSt. und VRG.

95031 – 13.8W Turn Track Schienenstrahler



Inklusive GLOBAL
3-Phasen Adapter



Spannung 220-240V AC, 50Hz
(inkl. 500mA Konverter / dimmbar)

Schutzart IP 20
Schutzklasse: I

LED **bridgelux** V10

Leistung 13.8W

Farbwiedergabe Ra 90

Optik Reflektor 45°

Dreh- und schwenkbar 355° / 90°

Material Gehäuse Aluminium

Massangaben ø100 × 103mm



Phasenabschnitt dimmbar mit
Feller LED Universaldimmer
40200.LED

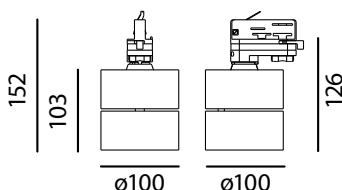

95031-27-02	2700K		1311lm		schwarz matt	298.00 CHF
95031-27-23	2700K		1311lm		schwarz / gold	298.00 CHF
95031-30-02	3000K		1375lm		schwarz matt	298.00 CHF

Alle Preise excl. MwSt. und VRG.



95055 – 8W Tube Track HV LED Schienenstrahler

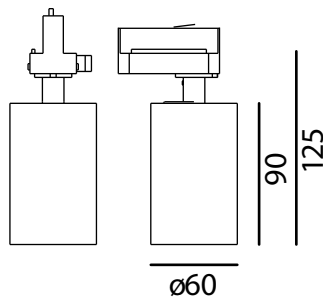

Spannung	220-240V AC, 50Hz (230V AC LED / dimmbar)	
Schutzart	IP 20	
Schutzklasse:	I	
LED	Lumens	EDC33C
Leistung	8W	
Farbwiedergabe Ra	90	
Optik	Reflektor 38° (26° auf Anfrage)	
Material Gehäuse	Aluminium	
Dreh- und schwenkbar	355° / 90°	
Massangaben	ø60 × 160mm	

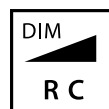

Phasenabschnitt dimmbar mit
Feller LED Universaldimmer
40200.LED



Inklusive GLOBAL 1-Phasen Stromschienenadapter

95055-27-00	2700K		680lm		weiss matt	98.00 CHF
95055-27-02	2700K		680lm		schwarz matt	98.00 CHF
95055-27-23	2700K		680lm		schwarz matt / gold	98.00 CHF
95055-27-75	2700K		680lm		silberfarbig	98.00 CHF
95055-30-00	3000K		760 lm		weiss matt	98.00 CHF
95055-30-02	3000K		760 lm		schwarz matt	98.00 CHF
95055-30-23	3000K		760 lm		schwarz matt / gold	98.00 CHF
95055-30-75	3000K		760 lm		silberfarbig	98.00 CHF

Reflektoren

95055-RF60-30		transparent	8.50 CHF
95055-RF60-03		gold	8.50 CHF
95055-RF60-02		schwarz	8.50 CHF

Alle Preise excl. MwSt. und VRG.



30030 / 30031 – Tube Track GU10 LED Schienenstrahler



Für Leuchtmittel Bauform **ausschliesslich LED GU10 bis max. 5W**

Fassung GU10 integriert

Schutzart IP 20

Schutzklasse: I

Material Gehäuse Aluminium

Dreh- und schwenkbar 355° / 90°

Massangaben ø60 × 90mm

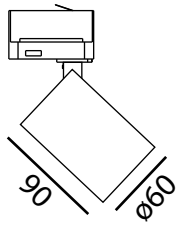

Inklusive GLOBAL 1-Phasen Stromschienenadapter

Code	Farbe	Preis
New 30030-00	weiss matt	68.00 CHF
30030-12	weiss matt / schwarz	68.00 CHF
30030-02	schwarz matt *	68.00 CHF
30030-75	silberfarbig	68.00 CHF



Inklusive GLOBAL 3-Phasen Stromschienenadapter

Code	Farbe	Preis
New 30031-00	weiss matt	72.00 CHF
30031-12	weiss matt / schwarz	72.00 CHF
30031-02	schwarz matt *	72.00 CHF
30031-75	silberfarbig	72.00 CHF

Filter



Code	Typ	Preis
95055-SF60	Soft Filter	8.50 CHF
95055-SL60	Prisma Filter	8.50 CHF
95055-WB60	Waben Filter	8.50 CHF

Reflektoren



Code	Farbe	Preis
95055-RF60-30	transparent	8.50 CHF
95055-RF60-03	gold	8.50 CHF
95055-RF60-02	schwarz	8.50 CHF

Alle Preise excl. MwSt. und VRG.

95056 – 12.2W Tube 60 Track LED Schienenstrahler

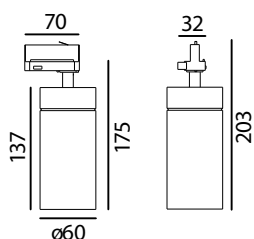

Spannung	220-240V AC, 50Hz (inkl. 350mA Konverter / dimmbar)
Schutzart	IP 20
Schutzklasse:	I
LED	bridgelux V10c
Leistung	12.2W
Farbwiedergabe Ra	90
Optik	Reflektor 48° (25° / 36° auf Anfrage) Schutzglas klar
Material Gehäuse	Aluminium
Dreh- und schwenkbar	355° / 90°
Massangaben	ø60 × 160mm



Phasenabschnitt dimmbar mit
Feller LED Universaldimmer
40200.LED



Inklusive GLOBAL 3-Phasen Adapter

95056-27-00	2700K	A G E	1456lm		weiss matt	198.00 CHF
95056-27-02	2700K	A G E	1456lm		schwarz matt	198.00 CHF
95056-27-23	2700K	A G E	1456lm		schwarz matt / gold	198.00 CHF
95056-27-75	2700K	A G E	1456lm		silberfarbig	198.00 CHF
95056-30-00	3000K	A G D	1525lm		weiss matt	198.00 CHF
95056-30-02	3000K	A G D	1525lm		schwarz matt	198.00 CHF
95056-30-23	3000K	A G D	1525lm		schwarz matt / gold	198.00 CHF
95056-30-75	3000K	A G D	1525lm		silberfarbig	198.00 CHF

Filter		
95055-SF60	Soft Filter	8.50 CHF
95055-SL60	Prisma Filter	8.50 CHF
95055-WB60	Waben Filter	8.50 CHF

Reflektoren		
95055-RF60-30	transparent	8.50 CHF
95055-RF60-03	gold	8.50 CHF
95055-RF60-02	schwarz	8.50 CHF



Alle Preise excl. MwSt. und VRG.

95056 – 13W Tube 60 DTW Track LED Schienenstrahler Dim to Warm



Spannung	220-240V AC, 50Hz (inkl. 350mA Konverter / dimmbar)	
Schutzart	IP 20	
Schutzklasse:	I	
LED	Prolight Optio	PDSQ-17VFL (DTW)
Leistung	13W	
Farbwiedergabe Ra	90	
Optik	Reflektor 48° (24° / 33° auf Anfrage)	
Dreh- und schwenkbar	35° / 90°	
Massangaben	ø60 × 160mm	

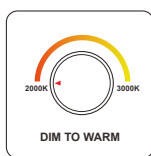
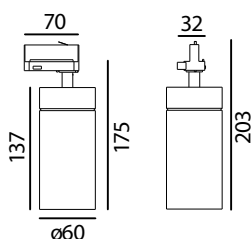

Dim to Warm Funktion nur mit einem Phasenabschnitt Dimmer möglich, z.B. Feller LED Universaldimmer 40200.LED



Phasenabschnitt dimmbar mit Feller LED Universaldimmer 40200.LED



Inklusive GLOBAL 3-Phasen Adapter

95056-50-00	2000–3000K	A F G	1100lm		weiss matt	214.00 CHF
95056-50-02	2000–3000K	A F G	1100lm		schwarz matt	214.00 CHF
95056-50-23	2000–3000K	A F G	1100lm		schwarz/gold	214.00 CHF
95056-50-75	2000–3000K	A F G	1100lm		silberfarbig	214.00 CHF

Filter



95055-SF60		Soft Filter	8.50 CHF
95055-SL60		Prisma Filter	8.50 CHF
95055-WB60		Waben Filter	8.50 CHF



Reflektoren

95055-RF60-30		transparent	8.50 CHF
95055-RF60-03		gold	8.50 CHF
95055-RF60-02		schwarz	8.50 CHF

Alle Preise excl. MwSt. und VRG.

95058 – 18.1W Tube 60 PRO LED Schienenstrahler

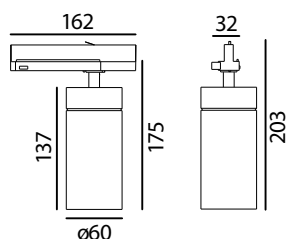

Spannung	220-240V AC, 50Hz (Stromquelle 350mA / nicht dimmbar)
Schutzart	IP 20
Schutzklasse:	
LED	bridgelux V10c
Leistung	18.1W
Farbwiedergabe Ra	90
Optik	Reflektor 48° (25° / 36° auf Anfrage) Schutzglas klar
Material Gehäuse	Aluminium
Dreh- und schwenkbar	355° / 90°
Massangaben	ø60 x 175mm

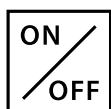

New	95058-30-00	3000K	A E	1887lm	weiss matt	278.00 CHF
New	95058-30-02	3000K	A E	1887lm	schwarz matt	278.00 CHF
New	95058-30-75	3000K	A E	1887lm	silberfarbig	278.00 CHF
New	95058-40-00	4000K	A D	2516lm	weiss matt	278.00 CHF
New	95058-40-02	4000K	A D	2516lm	schwarz matt	278.00 CHF
New	95058-40-75	4000K	A D	2516lm	silberfarbig	278.00 CHF

Filter



95055-SF60	t	Soft Filter	8.50 CHF
95055-SL60	t	Prisma Filter	8.50 CHF
95055-WB60	■	Waben Filter	8.50 CHF

Reflektoren



95055-RF60-30	t	transparent	8.50 CHF
95055-RF60-03	■	gold	8.50 CHF
95055-RF60-02	■	schwarz	8.50 CHF

Alle Preise excl. MwSt. und VRG.

95058 – 18.1W Tube 60 PRO DALI LED Schienenstrahler

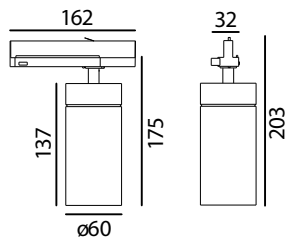

Spannung	220-240V AC, 50Hz (Stromquelle 350mA / DALI dimmbar)
Schutzart	IP 20
Schutzklasse:	
LED	bridgelux V10c
Leistung	18.1W
Farbwiedergabe Ra	90
Optik	Reflektor 48° (25° / 36° auf Anfrage)
Material Gehäuse	Aluminium
Dreh- und schwenkbar	355° / 90°
Massangaben	ø60 × 175mm



95058-30-00DA	3000K		1887lm		weiss matt	384.00 CHF
95058-30-02DA	3000K		1887lm		schwarz matt	384.00 CHF
95058-30-75DA	3000K		1887lm		silberfarbig	384.00 CHF
95058-40-00DA	4000K		2516lm		weiss matt	384.00 CHF
95058-40-02DA	4000K		2516lm		schwarz matt	384.00 CHF
95058-40-75DA	4000K		2516lm		silberfarbig	384.00 CHF

Filter



95055-SF60		Soft Filter	8.50 CHF
95055-SL60		Prisma Filter	8.50 CHF
95055-WB60		Waben Filter	8.50 CHF

Reflektoren



95055-RF60-30		transparent	8.50 CHF
95055-RF60-03		gold	8.50 CHF
95055-RF60-02		schwarz	8.50 CHF

Alle Preise excl. MwSt. und VRG.

95048 / 95049 – 9.3W Tube Track LED Schienenstrahler



Spannung	220-240V AC, 50Hz (inkl. 350mA Konverter / dimmbar)
Schutzart	IP 20
Schutzklasse:	I
LED	bridgelux V10
Leistung	9.3W
Farbwiedergabe Ra	90
Optik	Reflektor 45° (12° / 24° auf Anfrage) Schutzglas klar
Material Gehäuse	Aluminium
Dreh- und schwenkbar	355° / 90°
Massangaben	ø60 × 160mm

Auch erhältlich:

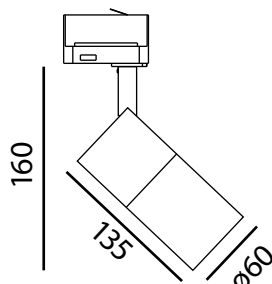

Phasenabschnitt dimmbar mit
Feller LED Universaldimmer
40200.LED



Inklusive GLOBAL 1-Phasen Stromschienenadapter

95048-27-00	2700K	A	E	956lm	weiss matt	184.00 CHF
95048-27-02	2700K	A	E	956lm	schwarz matt	184.00 CHF
95048-27-75	2700K	A	E	956lm	silberfarbig	184.00 CHF
95048-30-00	3000K	A	E	1003lm	weiss matt	184.00 CHF
95048-30-02	3000K	A	E	1003lm	schwarz matt	184.00 CHF
95048-30-75	3000K	A	E	1003lm	silberfarbig	184.00 CHF



Inklusive GLOBAL 3-Phasen Stromschienenadapter

95049-27-00	2700K	A	E	956lm	weiss matt	184.00 CHF
95049-27-02	2700K	A	E	956lm	schwarz matt	184.00 CHF
95049-27-75	2700K	A	E	956lm	silberfarbig	184.00 CHF
95049-30-00	3000K	A	E	1003lm	weiss matt	184.00 CHF
95049-30-02	3000K	A	E	1003lm	schwarz matt	184.00 CHF
95049-30-75	3000K	A	E	1003lm	silberfarbig	184.00 CHF

Alle Preise excl. MwSt. und VRG.

95038 – Sat 15W LED Schienenstrahler



Inklusive GLOBAL 3-Phasen Adapter



Strom DC	350mA (Bitte passenden Konverter dazu bestellen)
Schutzart	IP 20
Schutzklasse:	III
LED	CITILED The Light Engine
Leistung	15W
Farbwiedergabe Ra	92
Optik	Reflektor
Massangaben	ø290 × 150mm

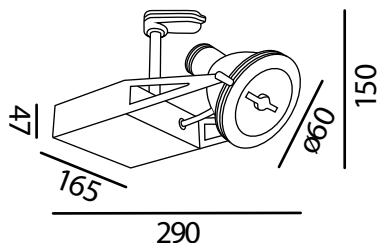

					Abstrahlwinkel	
New	95038-36-27	2700K		850lm	36°	248.00 CHF
New	95038-48-27	2700K		850lm	48°	248.00 CHF
New	95038-36-30	3000K		900lm	36°	248.00 CHF
New	95038-48-30	3000K		900lm	48°	248.00 CHF

Alle Preise excl. MwSt. und VRG.

30020 – Opus Aufbaustrahler

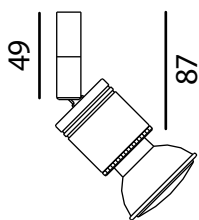

Für Leuchtmittel Bauform	ausschliesslich PAR16 (bitte dazu bestellen)
Fassung	GU10 integriert
Schutzart	IP 20
Schutzklasse:	I
Material Gehäuse	Aluminium
Dreh- und schwenkbar	355° / 90°
Montage	mit M10 × 1
Massangaben	L 118mm

30020-01	weiss	49.00 CHF
30020-04	chrom	59.00 CHF
30020-05	nickel satin	59.00 CHF
30020-55	nickel poliert	59.00 CHF
30020-75	silbergrau	49.00 CHF

Alle Preise excl. VRG, MwSt. und Leuchtmittel.

30021 – Domino Aufbaustrahler

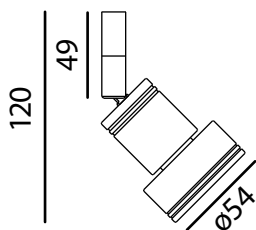

Für Leuchtmittel Bauform	ausschliesslich PAR16 (bitte dazu bestellen)
Fassung	GU10 integriert
Schutzart	IP 20
Schutzklasse:	I
Material Gehäuse	Aluminium
Dreh- und schwenkbar	355° / 90°
Montage	mit M10 × 1
Massangaben	L 129mm

30021-01	weiss	65.00 CHF
30021-02	schwarz matt	65.00 CHF
30021-04	chrom	75.00 CHF
30021-05	nickel satin	75.00 CHF
30021-55	nickel poliert	75.00 CHF
30021-75	silbergrau	65.00 CHF

Alle Preise excl. VRG, MwSt. und Leuchtmittel.

30022 – Conos Aufbaustrahler

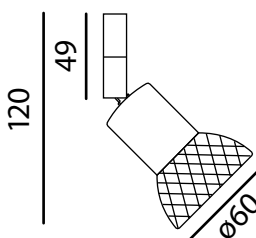

Für Leuchtmittel Bauform	ausschliesslich PAR16 (bitte dazu bestellen)
Fassung	GU10 integriert
Schutzart	IP 20
Schutzklasse:	I
Material Gehäuse	Aluminium
Dreh- und schwenkbar	355° / 90°
Montage	mit M10 × 1
Massangaben	L 122mm

30022-01	weiss	65.00 CHF
30022-04	chrom	75.00 CHF
30022-05	nickel satin	75.00 CHF
30022-55	nickel poliert	75.00 CHF
30022-75	silbergrau	65.00 CHF

Alle Preise excl. VRG, MwSt. und Leuchtmittel.

30023 – Zeno Aufbaustrahler

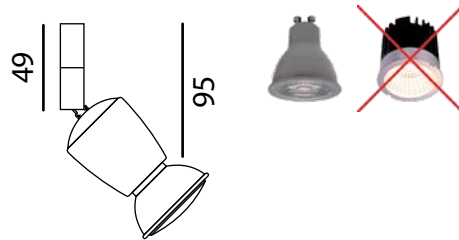

Für Leuchtmittel Bauform	ausschliesslich PAR16 (bitte dazu bestellen)
Fassung	GU10 integriert
Schutzart	IP 20
Schutzklasse:	I
Material Gehäuse	Aluminium
Dreh- und schwenkbar	355° / 90°
Montage	mit M10 × 1
Massangaben	L 127mm

30023-01	weiss	65.00 CHF
30023-04	chrom	75.00 CHF
30023-05	nickel satin	75.00 CHF
30023-55	nickel poliert	75.00 CHF
30023-75	silbergrau	65.00 CHF

Alle Preise excl. VRG, MwSt. und Leuchtmittel.

30024 – Focus Aufbaustrahler

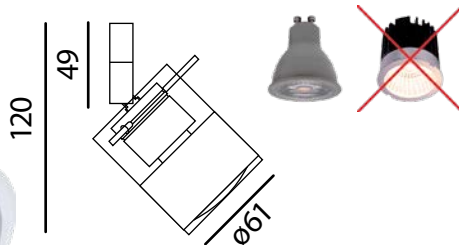

Für Leuchtmittel Bauform	ausschliesslich PAR16 (bitte dazu bestellen)
Fassung	GU10 integriert
Schutzart	IP 20
Schutzklasse:	I
Material Gehäuse	Aluminium
Dreh- und schwenkbar	355° / 90°
Montage	mit M10 × 1
Massangaben	L 120mm

30024-01	weiss	90.00 CHF
30024-04	chrom	98.00 CHF
30024-05	nickel satin	98.00 CHF
30024-55	nickel poliert	98.00 CHF
30024-75	silbergrau	90.00 CHF

Alle Preise excl. VRG, MwSt. und Leuchtmittel.

30025 – Cano Aufbaustrahler

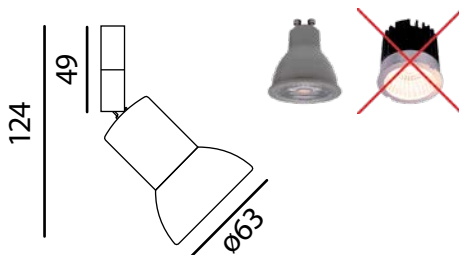

Für Leuchtmittel Bauform	ausschliesslich PAR16 (bitte dazu bestellen)
Fassung	GU10 integriert
Schutzart	IP 20
Schutzklasse:	I
Material Gehäuse	Aluminium
Dreh- und schwenkbar	355° / 90°
Montage	mit M10 × 1
Massangaben	L 125mm

30025-01	weiss	79.00 CHF
30025-04	chrom	89.00 CHF
30025-05	nickel satin	89.00 CHF
30025-55	nickel poliert	89.00 CHF
30025-75	silbergrau	79.00 CHF

Glas als weisse oder
blaue Version erhältlich

Alle Preise excl. VRG, MwSt. und Leuchtmittel.

30001 – Anbaugehäuse rund

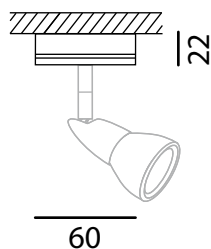
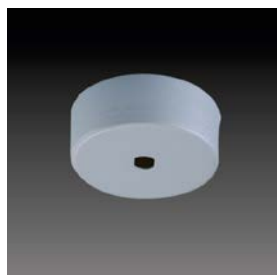

Schutzart	IP 20
Für Montage	mit M10 × 1
Abmessungen	ø60 × 22mm

30001-01	<input type="checkbox"/> weiss	24.00 CHF
30001-04	<input type="checkbox"/> chrom	34.00 CHF
30001-05	<input type="checkbox"/> nickel satin	34.00 CHF
30001-55	<input type="checkbox"/> nickel poliert	34.00 CHF
30001-75	<input type="checkbox"/> silberfarbig	24.00 CHF

Alle Preise excl. MwSt. und VRG.

30002 – Anbaugehäuse rund

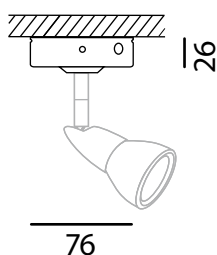

Schutzart	IP 20
Für Montage	mit M10 × 1
Abmessungen	ø76 × 26mm

30002-01	<input type="checkbox"/> weiss	28.00 CHF
30002-04	<input type="checkbox"/> chrom	38.00 CHF
30002-05	<input type="checkbox"/> nickel satin	38.00 CHF
30002-55	<input type="checkbox"/> nickel poliert	38.00 CHF
30002-75	<input type="checkbox"/> silberfarbig	28.00 CHF

Alle Preise excl. MwSt. und VRG.

30003 – Einbaumodul rund

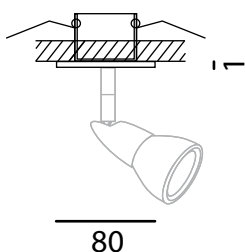

Schutzart	IP 20
Für Montage	mit M10 × 1
Abmessungen	ø80 × 11mm

30003-01	<input type="checkbox"/> weiss	28.00 CHF
30003-04	<input type="checkbox"/> chrom	38.00 CHF
30003-05	<input type="checkbox"/> nickel satin	38.00 CHF
30003-55	<input type="checkbox"/> nickel poliert	38.00 CHF
30003-75	<input type="checkbox"/> silberfarbig	28.00 CHF

Alle Preise excl. MwSt. und VRG.

30004 – Aufbaugehäuse eckig

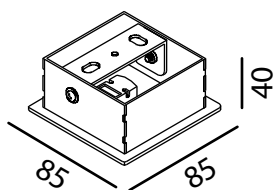

Schutzart	IP 20
Für Montage	mit M10 × 1
Abmessungen	L85 × 85mm / 40mm

30004-01	<input type="checkbox"/> weiss	36.00 CHF
30004-04	<input type="checkbox"/> chrom	46.00 CHF
30004-05	<input type="checkbox"/> nickel satin	46.00 CHF
30004-55	<input type="checkbox"/> nickel poliert	46.00 CHF
30004-75	<input type="checkbox"/> silberfarbig	36.00 CHF

Alle Preise excl. MwSt. und VRG.

30005 – Aufbaugehäuse eckig

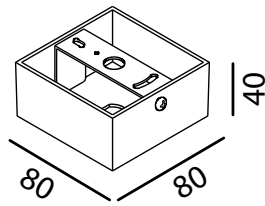
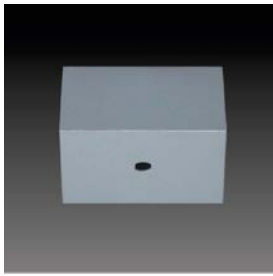

Schutzart IP 20

Für Montage mit M10 × 1

Abmessungen L80 × 80mm / 40mm

30005-01	<input type="checkbox"/> weiss	36.00 CHF
30005-04	<input type="checkbox"/> chrom	46.00 CHF
30005-05	<input type="checkbox"/> nickel satin	46.00 CHF
30005-55	<input type="checkbox"/> nickel poliert	46.00 CHF
30005-75	<input type="checkbox"/> silberfarbig	36.00 CHF

Alle Preise excl. MwSt. und VRG.

30006 – Aufbaugehäuse eckig

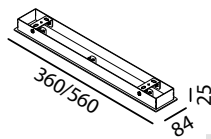

Schutzart IP 20

Für Montage mit M10 × 1

Abmessungen L82 × 360mm/560mm / 40mm

L360mm

30006-01	<input type="checkbox"/> weiss	38.00 CHF
30006-04	<input type="checkbox"/> chrom	49.00 CHF
30006-05	<input type="checkbox"/> nickel satin	49.00 CHF
30006-55	<input type="checkbox"/> nickel poliert	49.00 CHF
30006-75	<input type="checkbox"/> silberfarbig	38.00 CHF

L560mm

3007-01	<input type="checkbox"/> weiss	48.00 CHF
3007-04	<input type="checkbox"/> chrom	59.00 CHF
3007-05	<input type="checkbox"/> nickel satin	59.00 CHF
3007-55	<input type="checkbox"/> nickel poliert	59.00 CHF
3007-75	<input type="checkbox"/> silberfarbig	48.00 CHF

Alle Preise excl. MwSt. und VRG.

30009 – Anbaugehäuse eckig

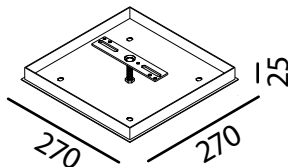

Schutzart IP 20

Für Montage mit M10 × 1

Abmessungen L270 × 270mm / 40mm

30009-01	<input type="checkbox"/> weiss	36.00 CHF
30009-04	<input type="checkbox"/> chrom	46.00 CHF
30009-05	<input type="checkbox"/> nickel satin	46.00 CHF
30009-55	<input type="checkbox"/> nickel poliert	46.00 CHF
30009-75	<input type="checkbox"/> silberfarbig	36.00 CHF

Alle Preise excl. MwSt. und VRG.

30008 – Aufbaugehäuse rund

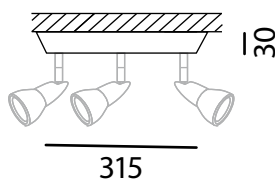

Schutzart IP 20

Für Montage mit M10 × 1

Abmessungen ø315 × 30mm

30008-01	<input type="checkbox"/> weiss	64.00 CHF
30008-04	<input type="checkbox"/> chrom	82.00 CHF
30008-05	<input type="checkbox"/> nickel satin	82.00 CHF
30008-55	<input type="checkbox"/> nickel poliert	82.00 CHF
30008-75	<input type="checkbox"/> silberfarbig	64.00 CHF

Alle Preise excl. MwSt. und VRG.

GLOBAL TRACK BASE 230V AC 1-Phasen Stromschiene

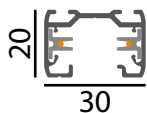
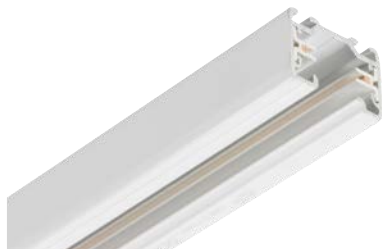

1-Phase Aufbau Stromschiene

	weiss matt	schwarz	Aluminium	
L=1m	GB 2100-3	GB 2100-2	GB 2100-1	57.00 CHF
L=2m	GB 2200-3	GB 2200-2	GB 2200-1	114.00 CHF
L=3m	GB 2300-3	GB 2300-2	GB 2300-1	171.00 CHF

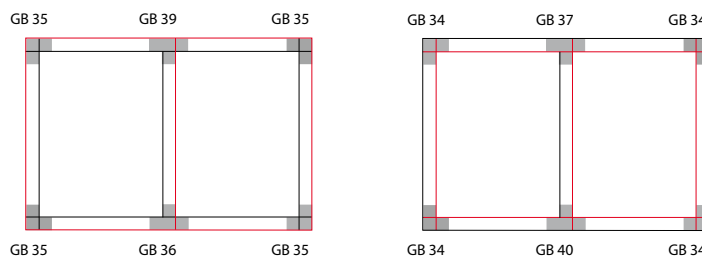
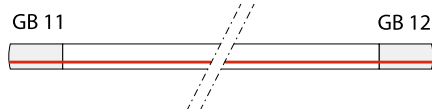





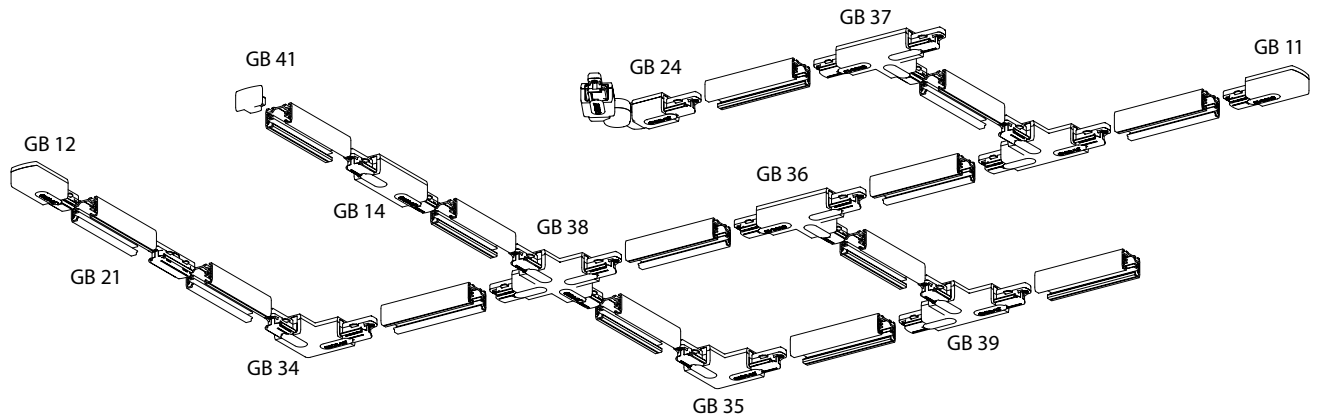





	weiss matt	schwarz	Aluminium	
Links Einspeisung	GB 11-3	GB 11-2	GB 11-1	23.00 CHF
Rechts Einspeisung	GB 12-3	GB 12-2	GB 12-1	23.00 CHF
Einspeisung Mitte	GB 14-3	GB 14-2	GB 14-1	37.00 CHF
Verbinder	GB 21-3	GB 21-2	GB 21-1	15.00 CHF
L-Form Verbinder	GB 34-3	GB 34-2	GB 34-1	52.00 CHF
L-Form Verbinder	GB 35-3	GB 35-2	GB 35-1	52.00 CHF
T-Form Verbinder	GB 36-3	GB 36-2	GB 36-1	76.00 CHF
T-Form Verbinder	GB 37-3	GB 37-2	GB 37-1	76.00 CHF
T-Form Verbinder	GB 39-3	GB 39-2	GB 39-1	76.00 CHF
T-Form Verbinder	GB 40-3	GB 40-2	GB 40-1	76.00 CHF
X-Form Verbinder	GB 38-3	GB 38-2	GB 38-1	76.00 CHF
Flexibler Verbinder 60–360°	GB 24-3	GB 24-2	GB 24-1	70.00 CHF
Endkappe	GB 41-3	GB 41-2	GB 41-1	4.00 CHF

Alle Preise excl. MwSt. und VRG.







**Adapter 1-Phase – 230V**

<input type="checkbox"/> weiss matt	<input type="checkbox"/> schwarz	<input type="checkbox"/> Grau	<input type="checkbox"/> Aluminium
-------------------------------------	----------------------------------	-------------------------------	------------------------------------

	6A – 5kg	GB 66-3	GB 66-2	GB 66-1	—	23.00 CHF
	M10 Alu Drehnippel H10mm	GA 57/10-3	GA 57/10-2	GA 57/10-1	GA 57/10-1	4.00 CHF
	Kunststoff Nippel mit Zugentlastung	GB 510-3	GB 510-2	GB 510-1	—	2.00 CHF
	10A – 10kg	GB 67-3	GB 67-2	GB 67-1	—	34.00 CHF
	M10 Alu Nippel H8mm	—	—	—	XTS 58/8-9	3.00 CHF
	M10 Alu Drehnippel H8mm	—	—	—	XTSA 57/8-9	3.00 CHF
	M10 Alu Drehnippel H12mm	—	XTSA 57/12-2	—	XTSA 57/12-9	3.00 CHF
	Kunststoff Zugentlastung Fur M10 Gewinde	XTSA 510-3	XTSA 510-2	XTSA 510-1	—	2.00 CHF
	M10 Mutter	—	—	—	GAM 10-9	1.00 CHF
	Drehbarer Metall Nippel mit M10 Gewinde	—	—	—	XTSA 63-9	3.00 CHF

Zubehör

<input type="checkbox"/> weiss matt	<input type="checkbox"/> schwarz	<input type="checkbox"/> Grau	<input type="checkbox"/> Aluminium
-------------------------------------	----------------------------------	-------------------------------	------------------------------------

	Deckenklammer M6	—	—	—	GBS 33-9	2.80 CHF
	Kupplungsverstärkung	—	—	—	GBS 18-9	9.30 CHF
	1m Deckenpendel	SP R6-3	SP R6-2	—	—	71.00 CHF
	1.5m Seilpendel M6	SPW 1-3	SPW 1-2	SPW 1-1	—	18.00 CHF
	Kunststoff Hackenhalter	GBA 14-3	GBA 14-2	GBA 14-1	—	4.00 CHF
	2mm Stahlhacken	—	—	XTAK 11-1	—	2.00 CHF

Alle Preise excl. MwSt. und VRG.

GLOBAL TRACK BASE 3-Phasen Stromschiene

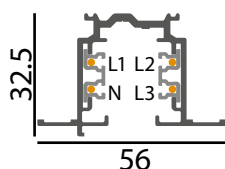
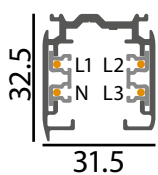
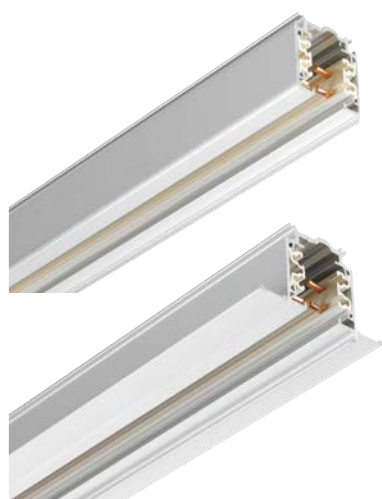

3-Phase Aufbau Stromschiene

weiss matt schwarz Aluminium

L=1m	XTS 4100-3	XTS 4100-2	XTS 4100-1	59.00 CHF
L=2m	XTS 4200-3	XTS 4200-2	XTS 4200-1	118.00 CHF
L=3m	XTS 4300-3	XTS 4300-2	XTS 4300-1	177.00 CHF

3-Phase Einbau Stromschiene

weiss matt schwarz Aluminium

L=1m	XTSF 4100-3	XTSF 4100-2	XTSF 4100-1	59.00 CHF
L=2m	XTSF 4200-3	XTSF 4200-2	XTSF 4200-1	118.00 CHF
L=3m	XTSF 4300-3	XTSF 4300-2	XTSF 4300-1	177.00 CHF

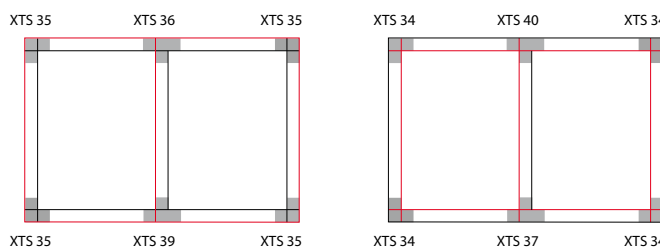
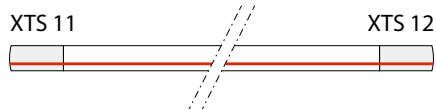

weiss matt schwarz Aluminium

		Links Einspeisung 3-Phase	XTS 11-3	XTS 11-2	XTS 11-1	31.00 CHF
		Rechts Einspeisung 3-Phase	XTS 12-3	XTS 12-2	XTS 12-1	31.00 CHF
		Einspeisung 3-Phase Mitte	XTS 14-3	XTS 14-2	XTS 14-1	67.00 CHF
		Verbinder	XTS 21-3	XTS 21-2	XTS 21-1	23.00 CHF
		L-Form Verbinder	XTS 34-3	XTS 34-2	XTS 34-1	63.00 CHF
		L-Form Verbinder	XTS 35-3	XTS 35-2	XTS 35-1	63.00 CHF
		T-Form Verbinder	XTS 36-3	XTS 36-2	XTS 36-1	91.00 CHF
		T-Form Verbinder	XTS 37-3	XTS 37-2	XTS 37-1	91.00 CHF
		T-Form Verbinder	XTS 39-3	XTS 39-2	XTS 39-1	91.00 CHF
		T-Form Verbinder	XTS 40-3	XTS 40-2	XTS 40-1	91.00 CHF
		X-Form Verbinder	XTS 38-3	XTS 38-2	XTS 38-1	110.00 CHF
		Flexibler Verbinder 60–360°	XTS 24-3	XTS 24-2	XTS 24-1	75.00 CHF
		Endkappe	XTS 41-3	XTS 41-2	XTS 41-1	5.00 CHF

Alle Preise excl. MwSt. und VRG.

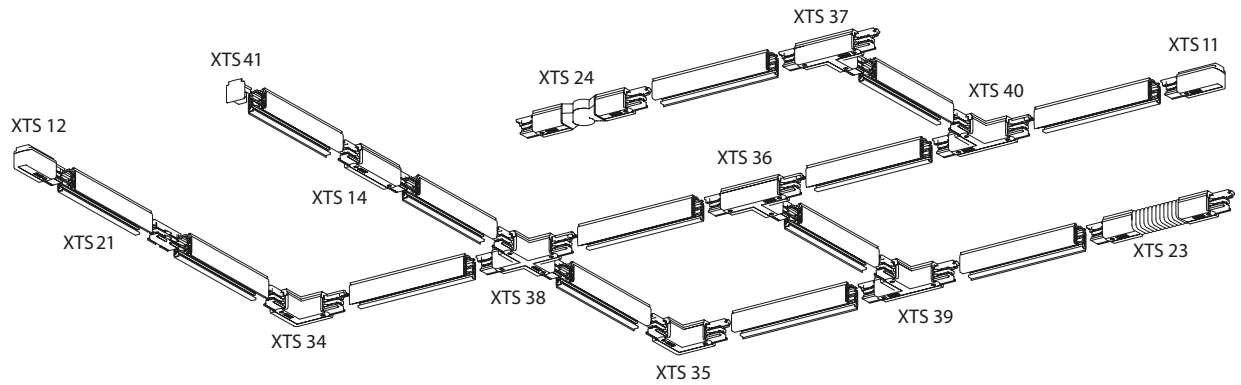

Adapter 3-Phasen – 230V		<input type="checkbox"/> weiss matt	<input checked="" type="checkbox"/> schwarz	<input type="checkbox"/> Grau	<input type="checkbox"/> Aluminium	
	6A – 5kg	GA69-3	GA69-2	GA69-1	—	28.00 CHF
	10A – 10kg	GA68-3	GA68-2	GA68-1	—	34.00 CHF
	Kunststoff Nippel mit Zugentlastung	GB 510-3	GB 510-2	GB 510-1	—	2.00 CHF
	M10 Alu Nippel H8mm	—	—	—	XTS 58/8-9	3.00 CHF
	M10 Alu Drehnippel H8mm	—	—	—	XTSA 57/8-9	3.00 CHF
	M10 Alu Drehnippel H12mm	—	XTSA 57/12-2	—	XTSA 57/12-9	3.00 CHF
	Kunststoff Zugentlastung Fur M10 Gewinde	XTSA 510-3	XTSA 510-2	XTSA 510-1	—	2.00 CHF
	M10 Mutter	—	—	—	GAM 10-9	1.00 CHF
	Drehbarer Metall Nippel mit M10 Gewinde	—	—	—	XTSA 63-9	3.00 CHF
Zubehör		<input type="checkbox"/> weiss matt	<input checked="" type="checkbox"/> schwarz	<input type="checkbox"/> Grau	<input type="checkbox"/> Aluminium	
	Einbauring	XSTA 71-3	XSTA 71-2	XSTA 71-1		54.00 CHF
	Deckendose	GA 70-3	GA 70-2	GA 70-1		84.00 CHF
	Kunststoff Hackenhalter	XTAK 142-3	XTAK 142-2	XTAK 142-1		4.00 CHF
	2mm Stahlhacken	—	—	XTAK 11-1	—	2.00 CHF
	Deckenklammer	SKB 12-3	SKB 12-2	SKB 12-1		5.00 CHF
	Aufhängebrücke	SKB 18-3	—	SKB 18-1		14.00 CHF
	Flügelplatte	XTSF 10-3	XTSF 10-2	—		6.00 CHF
	Abdeckstreifen 3m	XTSP 11-3	—	—		12.00 CHF
	Seilset 1.5m	SPWFG-3/1.5	SPWFG-2/1.5	SPWFG-1/1.5		21.00 CHF
	Seilset 3m	SPWFG-3/3	SPWFG-2/3	SPWFG-1/3		24.00 CHF
	Leiterbiegeschlüssel			XTSV 12		27.00 CHF

Alle Preise excl. MwSt. und VRG.

GLOBAL TRACK Pulse DALI Stromschiene

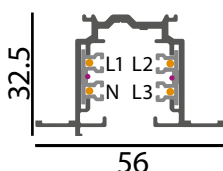
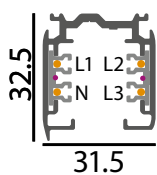

3-Phase DALI Aufbau Stromschiene

weiss matt
 schwarz
 Aluminium

L=1m	XTSC 6100-3	XTSC 6100-2	XTSC 6100-1	71.00 CHF
L=2m	XTSC 6200-3	XTSC 6200-2	XTSC 6200-1	142.00 CHF
L=3m	XTSC 6300-3	XTSC 6300-2	XTSC 6300-1	213.00 CHF

3-Phase DALI Einbau Stromschiene

weiss matt
 schwarz
 Aluminium

L=1m	XTSCF 6100-3	XTSCF 6100-2	XTSCF 6100-1	71.00 CHF
L=2m	XTSCF 6200-3	XTSCF 6200-2	XTSCF 6200-1	142.00 CHF
L=3m	XTSCF 6300-3	XTSCF 6300-2	XTSCF 6300-1	213.00 CHF

			 weiss matt schwarz Aluminium			
		Links Einspeisung 3-Phase	XTSC 611-3	XTSC 611-2	XTSC 611-1	44.00 CHF
		Rechts Einspeisung 3-Phase	XTSC 612-3	XTSC 612-2	XTSC 612-1	44.00 CHF
		Einspeisung 3-Phase Mitte	XTSC 614-3	XTSC 614-2	XTSC 614-1	93.00 CHF
		Verbinder	XTSC 621-3	XTSC 621-2	XTSC 621-1	93.00 CHF
		L-Form Verbinder	XTSC 634-3	XTSC 634-2	XTSC 634-1	114.00 CHF
		L-Form Verbinder	XTSC 635-3	XTSC 635-2	XTSC 635-1	114.00 CHF
		T-Form Verbinder	XTSC 636-3	XTSC 636-2	XTSC 636-1	142.00 CHF
		T-Form Verbinder	XTSC 637-3	XTSC 637-2	XTSC 637-1	142.00 CHF
		T-Form Verbinder	XTSC 639-3	XTSC 639-2	XTSC 639-1	142.00 CHF
		T-Form Verbinder	XTSC 640-3	XTSC 640-2	XTSC 640-1	142.00 CHF
		X-Form Verbinder	XTSC 638-3	XTSC 638-2	XTSC 638-1	213.00 CHF
		Flexibler Verbinder 60–360°	XTSC 623-3	XTSC 623-2	XTSC 623-1	93.00 CHF
		Endkappe	XTS 41-3	XTS 41-2	XTS 41-1	4.00 CHF
		Deckenklammer	SKB 12-3	SKB 12-2	SKB 12-1	5.00 CHF
		Aufhängebrücke	SKB 18-3	—	SKB 18-1	14.00 CHF
		Flügelplatte	XTSF 610-3	XTSF 610-2	XTSF 610-1	6.00 CHF
		Abdeckstreifen 3m	XTSP 11-3	XTSP 11-2	—	12.00 CHF

Alle Preise excl. MwSt. und VRG.

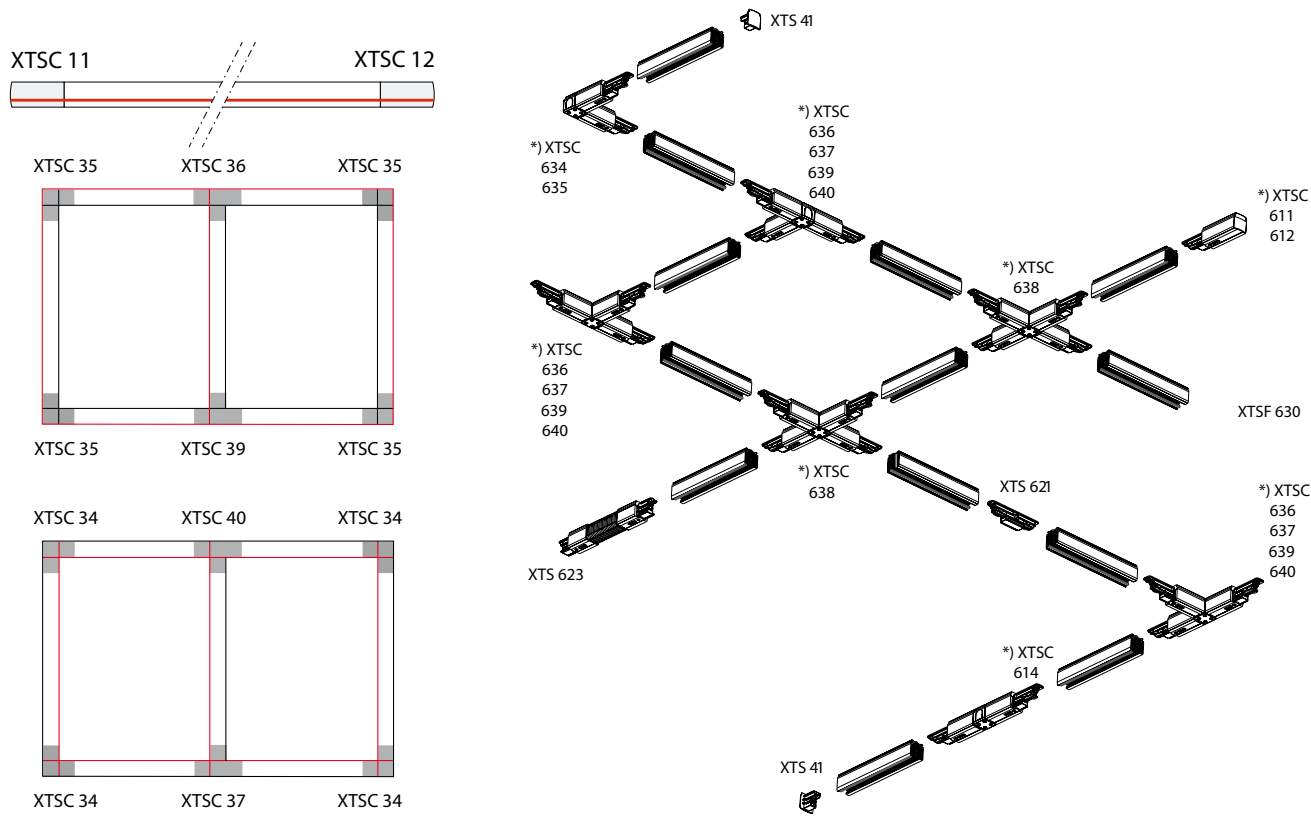

Adapter 3-Phase DALI – 230V

weiss matt
 schwarz
 Grau
 Aluminium

	6A – 5kg	GAC 69-3	GAC 69-2	GAC 69-1	—	51.00 CHF
	10A – 10kg	GAC 600-3	GAC 600-2	GAC 600-1	—	58.00 CHF
	Kunststoff Nippel mit Zugentlastung	GB 510-3	GB 510-2	GB 510-1	—	2.00 CHF
	M10 Alu Nippel H8mm	—	—	—	XTS 58/8-9	3.00 CHF
	M10 Alu Drehnippel H8mm	—	—	—	XTSA 57/8-9	3.00 CHF
	M10 Alu Drehnippel H12mm	—	XTSA 57/12-2	—	XTSA 57/12-9	3.00 CHF
	Kunststoff Zugentlastung Fur M10 Gewinde	XTSA 510-3	XTSA 510-2	XTSA 510-1	—	2.00 CHF
	M10 Mutter	—	—	—	GAM 10-9	1.00 CHF
	Drehbarer Metall Nippel mit M10 Gewinde	—	—	—	XTSA 63-9	3.00 CHF

Zubehör

weiss matt
 schwarz
 Grau
 Aluminium

	Kunststoff Hackenhalter	XTAK 142-3	XTAK 142-2	XTAK 142-1	—	4.00 CHF
	2mm Stahlhacken	—	—	XTAK 11-1	—	2.00 CHF
	Seilset 1.5m	SPWFG-3/1.5	SPWFG-2/1.5	SPWFG-1/1.5	—	21.00 CHF
	Seilset 3m	SPWFG-3/3	SPWFG-2/3	SPWFG-1/3	—	24.00 CHF
	Leiterbiegeschlüssel			XTSV 12		27.00 CHF

Alle Preise excl. MwSt. und VRG.





178 63031

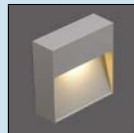

179 63030

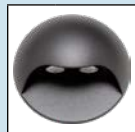

180 5577



180 5571



181 Inground 110R



181 Inground 110Q

Aussenstrahler



63031 – 3W LED Wandanbaustrahler IP65

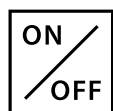
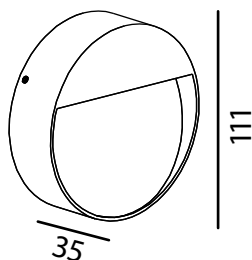

63031-27-80	2700K			331lm		grau	114.00 CHF
63031-27-85	2700K			331lm		dunkelgrau	114.00 CHF

Alle Preise excl. MwSt. und VRG.



Spannung 220-240V AC, 50Hz
(inkl. 350mA Konverter / nicht dimmbar)

Schutzart IP 65

Schutzklasse: I

LED V6

Leistung 3W

Farbwiedergabe Ra 80

Lichtaustritt Asymmetrisch

Material Gehäuse Aluminium





Anbau Montageplatte

Massangaben $\varnothing 111 \times 35\text{mm}$

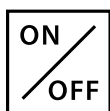
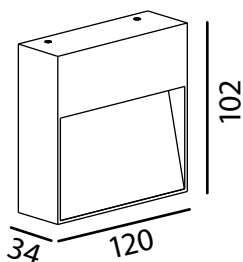

63030 – 3W LED Wandanbaustrahler IP65



63030-27-80	2700K		331lm	 grau	128.00 CHF
63030-27-85	2700K		331lm	 dunkelgrau	128.00 CHF

Alle Preise excl. MwSt. und VRG.



Spannung	220-240V AC, 50Hz (inkl. 350mA Konverter / nicht dimmbar)
Schutzart	IP 65
Schutzklasse:	I
LED	bridgelux. V6
Leistung	3W
Farbwiedergabe Ra	80
Lichtaustritt	Asymmetrisch
Material Gehäuse	Aluminium
Anbau	Montageplatte
Massangaben	102 × 102 × 34mm

5577 – 2 x 3W LED Wandanbaustrahler IP54



Spannung	220-240V AC, 50Hz (inkl. 700mA Konverter / nicht dimmbar)
Schutzart	IP 54
Schutzklasse:	I
LED	CREE XP-E
Leistung	2 x 3W
Farbwiedergabe Ra	80
Optik	Linse
Material Gehäuse	Aluminium
Anbau	Montageplatte
Massangaben	ø130 x 61mm

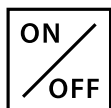
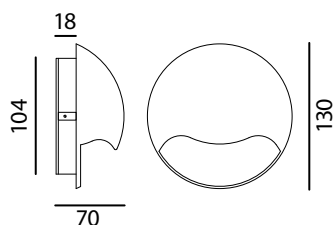

5577-27-75	2700K	A G	2 x 140lm	silberfarbig	128.00 CHF
5577-27-90	2700K	A G	2 x 140lm	anthrazit	128.00 CHF

Alle Preise excl. MwSt. und VRG.

5571 – 3W LED Wandeinbaustrahler IP65



Spannung	220-240V AC, 50Hz (inkl. 700mA Konverter / nicht dimmbar)
Schutzart	IP 65
Schutzklasse:	I
LED	CREE XP-E
Leistung	3W
Farbwiedergabe Ra	80
Lichtaustritt	Asymmetrisch Schutzglas Opal
Material Gehäuse	Aluminium
Einbau	Inkl. Kunststoff Einbaudose
Ausschnitt / Einbautiefe	AS 101 x 101mm / ET 70
Massangaben Leuchte	102 x 102 x 59mm
Einbaudose	100 x 100 x 70mm

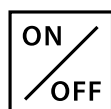
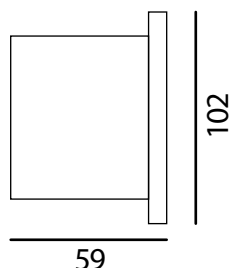

5571-30-75	3000K	A G	140lm	silberfarbig	178.00 CHF
5571-30-85	3000K	A G	140lm	dunkelgrau	178.00 CHF
5571-30-95	3000K	A G	140lm	braun	178.00 CHF

Alle Preise excl. MwSt. und VRG.

Inground 110R – LED Bodeneinbaustrahler für den Aussenbereich IP68



Für Leuchtmittel Bauform	ausschliesslich PAR16 (bitte dazu bestellen)
Fassung	GU10 integriert
Schutzart	IP 68 / IK 09
Schutzklasse	III
Material Gehäuse	Stahl rostfrei AISI 316
Belastbar	max. 2000kg
Einbau	Inkl. Bodeneinbaudose
Massangaben	ø120mm ET127

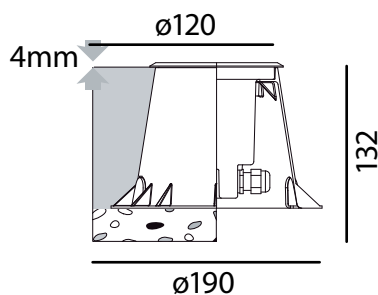

07352-30 inox

158.10 CHF

Alle Preise excl. VRG, MwSt. und Leuchtmittel.

Inground 110Q – LED Bodeneinbaustrahler für den Aussenbereich IP68



Für Leuchtmittel Bauform	ausschliesslich PAR16 (bitte dazu bestellen)
Fassung	GU10 integriert
Schutzart	IP 68 / IK 09
Schutzklasse	III
Material Gehäuse	Stahl rostfrei AISI 316
Belastbar	max. 2000kg
Einbau	Inkl. Bodeneinbaudose
Massangaben	120 × 120mm ET132

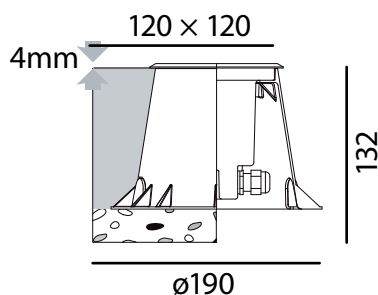

7354-30 inox

178.30 CHF

Alle Preise excl. VRG, MwSt. und Leuchtmittel.



184 Konverter
an / aus



186 Konverter
[R C] dimmbar



188 Konverter
1-10 / Push



190 Konverter
DALI / Push



196
DALI Steuerung



198
230V AC Dimmer



196
230V 12W LED



196 CASAMBI
Empfänger



205 CASAMBI
Konverter



208 CASAMBI
Sender



210 HaloX-100
Einbagehäuse



211 HaloX-180
Einbagehäuse



212
Firestop-Boxen



212
Wandeinbau-Box



213
Kabelverbinder



213
Kabelkupplung

Konverter & Zubehör

350mA LED Konverter

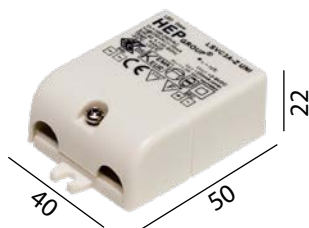

Schutzart	IP 20
Primärseitig	100-240V AC 50/60Hz
Umgebungstemp.	-20 – 50°C
Messpunkt tc	75°C
Dimmbar	—
Abmessungen	50 × 40 × 22mm

73003-KL	350mA	1-3W mit Schraubklemme	32.00 CHF
73003-S	350mA	1-3W mit Stecker	28.00 CHF



Zubehör		
72001	Verteiler 3-fach	6.50 CHF

Alle Preise excl. MwSt. und VRG.

700mA LED Konverter



Schutzart	IP 20
Primärseitig	100-240V AC 50/60Hz
Umgebungstemp.	-20 – 50°C
Messpunkt tc	75°C
Dimmbar	—
Abmessungen	58 × 39 × 20mm

73007	700mA	3.5W	32.00 CHF
--------------	--------------	-------------	------------------

Alle Preise excl. MwSt. und VRG.

350mA LED Konverter



Schutzart	IP 20
Primärseitig	100-240V AC 50/60Hz
Umgebungstemp.	-20 – 50°C
Messpunkt tc	70°C
Dimmbar	—
Abmessungen	85 × 40 × 22mm

73004	350mA	1-8W mit Stecker	36.00 CHF
--------------	--------------	-------------------------	------------------

Zubehör		
72002	Verteiler 6-fach	9.50 CHF

Alle Preise excl. MwSt. und VRG.

350/500mA LED Konverter



Schutzart	IP 20
Primärseitig	100-240V AC 50/60Hz
Umgebungstemp.	-25 – 45/50°C
Messpunkt tc	75°C
Dimmbar	—
Abmessungen	60 × 35 × 22mm



730004	350mA	1-8W	31.00 CHF
730009	500mA	1-6W	31.00 CHF

Alle Preise excl. MwSt. und VRG.

350 / 500 / 700mA LED Konverter



Schutzart	IP 20
Primärseitig	110-240V AC 50/60Hz
Umgebungstemp.	-25 – 45/50°C
Messpunkt tc	70/80°C
Dimmbar	—
Abmessungen	122 × 38 × 28mm



730023	350mA	1-17W	46.00 CHF
730046	500mA	2-20W	66.00 CHF
730034	700mA	2-17W	46.00 CHF

Alle Preise excl. MwSt. und VRG.

350 / 700mA LED Konverter

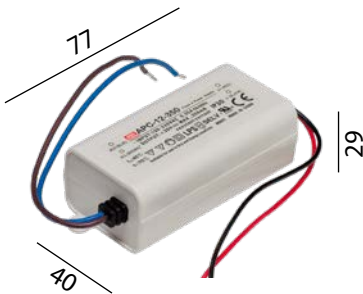

Schutzart	IP 30
Primärseitig	100-240V AC 50/60Hz
Umgebungstemp.	-30 – 70°C
Messpunkt tc	75/80°C
Dimmbar	—
Abmessungen	77 × 40 × 29mm



730010	350mA	3-12W	35.00 CHF
730011	350mA	4-16W	39.00 CHF
730012	700mA	6-12W	35.00 CHF
730013	700mA	6-16W	39.00 CHF

Alle Preise excl. MwSt. und VRG. Solange der Vorrat reicht

350 / 500 / 700mA LED Konverter



Schutzart	IP 30
Primärseitig	100-240V AC 50/60Hz
Umgebungstemp.	-30 – 70°C
Dimmbar	—
Abmessungen	84 × 57 × 29.5mm



730005	350mA	10-35W	83.00 CHF
730006	500mA	12-35W	83.00 CHF
730007	700mA	10-35W	83.00 CHF

Alle Preise excl. MwSt. und VRG. Solange der Vorrat reicht

350 / 500 / 700mA LED Konverter



Phasenabschnitt dimmbar mit Feller LED Universaldimmer 40200.LED



Schutzart	IP 20
Primärseitig	220-240V AC 50/60Hz
Umgebungstemp.	-20 – 45°C
Messpunkt tc	70°C
Dimmbar	mit Phasenabschnittdimmer [R C]
Abmessungen	62 × 50 × 22mm

730096	350mA	4.2-9.8W	59.00 CHF
730097	500mA	4.5-10W	59.00 CHF
730098	700mA	4.2-9.8W	59.00 CHF

Alle Preise excl. MwSt. und VRG.

500mA LED Konverter

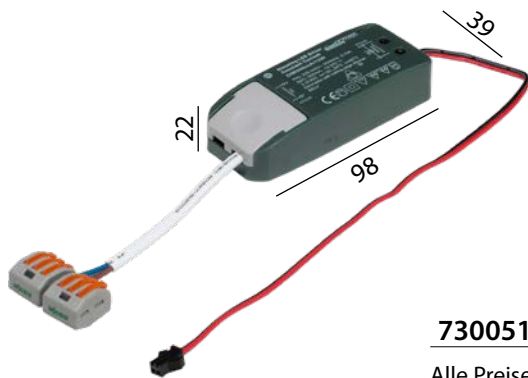

Phasenabschnitt dimmbar mit Feller LED Universaldimmer 40200.LED



Schutzart	IP 20
Primärseitig	200-240V AC 50/60Hz
Umgebungstemp.	-25 – 50°C
Messpunkt tc	80°C
Dimmbar	mit Phasenabschnittdimmer [R C]
Abmessungen	98 × 39 × 22mm

Vorverkabelt, inklusive WAGO Klemmen

730051	500mA	6-12W	36.00 CHF
--------	-------	-------	-----------

Alle Preise excl. MwSt. und VRG.

350 / 500mA LED Konverter

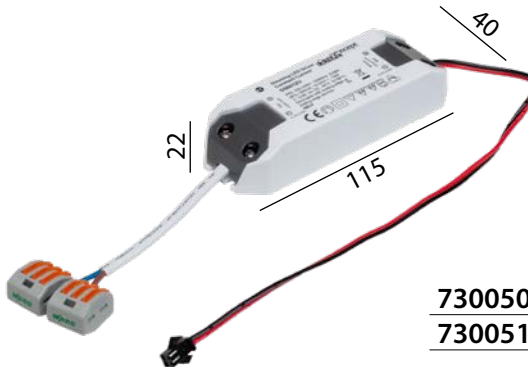

Phasenabschnitt dimmbar mit Feller LED Universaldimmer 40200.LED



Schutzart	IP 20
Primärseitig	220-240V AC 50/60Hz
Umgebungstemp.	-20 – 45/50°C
Messpunkt tc	80/90°C
Dimmbar	mit Phasenabschnittdimmer [R C]
Abmessungen	115 × 40 × 22mm

Vorverkabelt, inklusive WAGO Klemmen

730050-U	350mA	4-9W	36.00 CHF
730051-U	500mA	6-12W	36.00 CHF

Alle Preise excl. MwSt. und VRG.

350 / 450mA LED Konverter

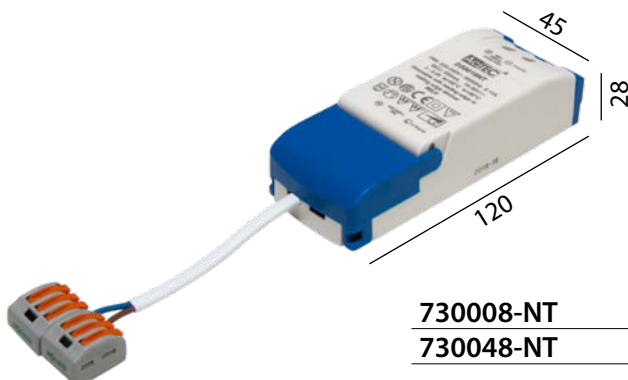

Schutzart	IP 20
Primärseitig	220-240V AC 50/60Hz
Umgebungstemp.	-20 – 50°C
Messpunkt tc	80°C
Dimmbar	mit Phasen- und Phasenabschnittdimmer [L C]
Abmessungen	120 × 45 × 28mm

Vorverkabelt, inklusive WAGO Klemmen

730008-NT	350mA	9-18W	49.00 CHF
730048-NT	450mA	9-18W	49.00 CHF

Alle Preise excl. MwSt. und VRG.

350 / 500 / 700mA LED Konverter



Phasenabschnitt dimmbar mit
Feller LED Universaldimmer
40200.LED



Schutzart	IP 20
Primärseitig	220-240V AC 50/60Hz
Umgebungstemp.	-20 – 50°C
Messpunkt tc	90°C
Dimmbar	mit Phasenabschnittdimmer [R C]
Abmessungen	113 × 44 × 28mm

730008	350mA	5-18W	49.00 CHF
730048	500mA	5-18W	49.00 CHF
RN 1408	700mA	5-18W	49.00 CHF

Alle Preise excl. MwSt. und VRG. Solange der Vorrat reicht.

350 / 500mA LED Konverter



Phasenabschnitt dimmbar mit
Feller LED Universaldimmer
40200.LED



Schutzart	IP 20
Primärseitig	220-240V AC 50/60Hz
Umgebungstemp.	-20 – 45°C
Messpunkt tc	85°C
Dimmbar	mit Phasenabschnittdimmer [R C]
Abmessungen	127 × 44 × 28mm

73141	350mA	9.8-19.6W	69.00 CHF
73142	500mA	10-22W	69.00 CHF

Alle Preise excl. MwSt. und VRG.

350 / 700 / 1050mA LED Konverter



Schutzart	IP 30
Primärseitig	220-240V AC 50/60Hz
Umgebungstemp.	-30 – 60°C
Messpunkt tc	70°
Dimmbar	mit Phasenabschnittdimmer [R C]
Abmessungen	84 × 57 × 29.5mm

730015	350mA	8-16W	46.00 CHF
730024	350mA	10-20W	62.00 CHF
730016	700mA	11-16W	46.00 CHF
730025	700mA	16-25W	62.00 CHF
730017	1050mA	13-16W	92.00 CHF

Alle Preise excl. MwSt. und VRG.
Solange der Vorrat reicht

350 / 500 / 700mA LED Konverter



Schutzart	IP 30
Primärseitig	200-240V AC 50/60Hz
Umgebungstemp.	-40 – 80°C
Messpunkt tc	90°C
Dimmbar	mit Phasenabschnittdimmer [R C]
Abmessungen	128 × 60 × 31.5mm

730019	350mA	25-37W	90.00 CHF
730018	500mA	22-40W	90.00 CHF
730020	500mA	35-54W	96.00 CHF
730021	700mA	23-40W	90.00 CHF
730022	700mA	35-60W	96.00 CHF

Alle Preise excl. MwSt. und VRG.
Solange der Vorrat reicht

Multi LED Konverter Smart 32



Schutzart	IP 20
Primärseitig	200-240V AC 50/60Hz
Umgebungstemp.	-25 – 50°C
Messpunkt tc	80°C
Dimmbar	—
Abmessungen	130 × 42 × 30mm

SEC Pout	250mA 11W	300mA 13W	350mA 16W	400mA 18W	450mA 20W	500mA 22W	550mA 25W	600mA 27W
SEC Pout	650mA 29W	700mA 32W	750mA 32W	800mA 32W	850mA 32W	900mA 32W	950mA 32W	1000mA 32W

730049 250...1000mA 11...32W 83.00 CHF

Alle Preise excl. MwSt. und VRG.

Multi 1-10V / Push DIM LED Konverter JOLLY

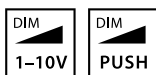

Schutzart	IP 20
Primärseitig	220-240V AC 50/60Hz
Umgebungstemp.	-25 – 50°C
Messpunkt tc	75°C
Dimmbar	1-10V / Push DIM
Abmessungen	103 × 67 × 21mm

SEC Pout	250mA 14W	350mA 19W	400mA 22W	450mA 25W	500mA 25W	550mA 25W	600mA 25W	12V DC 8W	24V DC 17W	28V DC 20W
----------	--------------	--------------	--------------	--------------	--------------	--------------	--------------	--------------	---------------	---------------

730043 350...700mA 10...24V DC 18...25W 92.00 CHF

Alle Preise excl. MwSt. und VRG.

Multi 1-10V / Push DIM LED Konverter JOLLY DIN

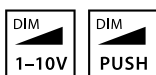

Schutzart	IP 20
Primärseitig	220-240V AC 50/60Hz
Umgebungstemp.	-25 – 50°C
Messpunkt tc	75°C
Dimmbar	1-10V / Push DIM
Abmessungen	90 × 70 × 36mm

SEC Pout	200mA 10W	250mA 13W	300mA 16W	350mA 19W	400mA 21W	450mA 24W	500mA 27W
SEC Pout	550mA 29W	600mA 32W	650mA 32W	700mA 32W	750mA 32W	800mA 32W	

Alle Preise excl. MwSt. und VRG. **730068 200...800mA 10...32W 139.00 CHF**

350 / 500mA 1-10V / Push DIM LED Konverter MICRO JOLLY



Schutzart	IP 20
Primärseitig	220-240V AC 50/60Hz
Umgebungstemp.	-25 – 50°C
Messpunkt tc	70°C
Dimmbar	1-10V / Taster potentialfrei
Abmessungen	57 × 50 × 22mm



730045	350mA	1-6W	50.00 CHF
730044	500mA	1-6W	59.00 CHF

Alle Preise excl. MwSt. und VRG.

Multi 1-10V / Push DIM LED Konverter

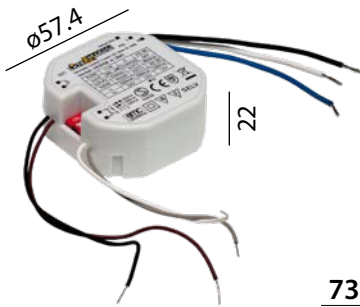

Schutzart	IP 20
Primärseitig	220-240V AC 50/60Hz
Umgebungstemp.	-20 – 50°C
Messpunkt tc	80°C
Dimmbar	1-10V / Push DIM
Abmessungen	ø57.4 × 22mm

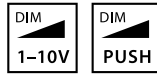

SEC	350mA	500mA	550mA
Pout	8W	8W	8W

730065	350...550mA	8W	56.00 CHF
--------	-------------	----	-----------

Alle Preise excl. MwSt. und VRG. Solange der Vorrat reicht

Multi 1-10V / Push DIM LED Konverter MINI JOLLY



Schutzart	IP 20
Primärseitig	110-240V AC 50/60Hz
Umgebungstemp.	-25 – 50°C
Messpunkt tc	80°C
Dimmbar	1-10V / Push DIM
Abmessungen	111 × 52 × 22mm



SEC	350mA	500mA	550mA	700mA	850mA	900mA	10V DC	12V DC	24V DC
Pout	15W	20W	20W	20W	20W	20W	9W	10W	20W

730042	350...900mA	10...24V DC	9...20W	78.00 CHF
--------	-------------	-------------	---------	-----------

Alle Preise excl. MwSt. und VRG.

Multi 1-10 / Push DIM LED Konverter MAXI JOLLY SLIM HV (mit höherer Leistung)



Schutzart	IP 20
Primärseitig	220-240V AC 50/60Hz
Umgebungstemp.	-25 – 45°C
Messpunkt tc	75°C
Dimmbar	1-10V / Push DIM
Abmessungen	280 × 40 × 22mm

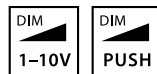

SEC	250mA	350mA	400mA	450mA	500mA	550mA	600mA	700mA	58V DC
Pout	30W	40W	47W	50W	55W	60W	60W	60W	40W

730067	250...700mA	58V DC	30...60W	155.00 CHF
--------	-------------	--------	----------	------------

Alle Preise excl. MwSt. und VRG.

Multi / Push DIM LED Konverter PRO BI



Schutzart	IP 20
Primärseitig	220-240V AC 50/60Hz
Umgebungstemp.	-25 – 45°C
Messpunkt tc	80°C
Dimmbar	DALI / Push DIM
Abmessungen	97 × 42 × 30mm

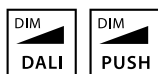

SEC	300mA	350mA	400mA	450mA	500mA	550mA	600mA	650mA
Pout	16W	18W	21W	24W	27W	29W	32W	35W
SEC	700mA	750mA	800mA	850mA	900mA	950mA	1000mA	1050mA
Pout	38W	38W	38W	38W	38W	38W	38W	38W

730093

300...1050mA

16...38W

Alle Preise excl. MwSt. und VRG.

98.00 CHF

Multi / Push Dim LED Konverter PRO



Schutzart	IP 20
Primärseitig	220-240V AC 50/60Hz
Umgebungstemp.	-25 – 45°C
Messpunkt tc	80°C
Dimmbar	DALI / Push DIM
Abmessungen	130 × 42 × 30mm



SEC	300mA	350mA	400mA	450mA	500mA	550mA	600mA	650mA
Pout	16W	18W	21W	24W	27W	29W	32W	35W
SEC	700mA	750mA	800mA	850mA	900mA	950mA	1000mA	1050mA
Pout	38W	38W	38W	38W	38W	38W	38W	38W

730094

300...1050mA

16...38W

Alle Preise excl. MwSt. und VRG.

102.00 CHF

Multi LED Konverter JOLLY

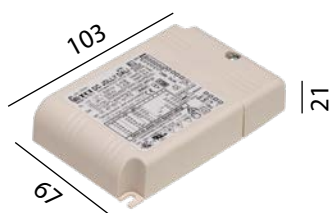

Schutzart	IP 20
Primärseitig	200-240V AC 50/60Hz
Umgebungstemp.	-25 – 50°C
Messpunkt tc	75°C
Dimmbar	DALI
Abmessungen	103 × 67 × 21mm



SEC	350mA	500mA	550mA	700mA	10V DC	12V DC	24V DC
Pout	17W	24W	25W	32W	9W	10W	20W

730041

350...700mA

10...24V DC

9...32W

Alle Preise excl. MwSt. und VRG.

89.00 CHF

Multi / 1-10V / Push DIM

LED Konverter MAXI JOLLY HV

(mit höherer Leistung)

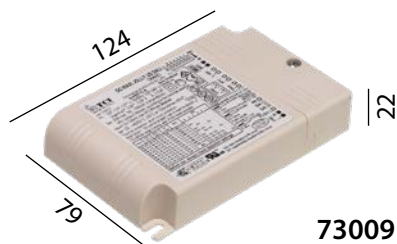

Schutzart	IP 20
Primärseitig	220-240V AC 50/60Hz
Umgebungstemp.	-25 – 50°C
Messpunkt tc	90°C
Dimmbar	DALI / 1-10V / Push DIM
Abmessungen	124 × 79 × 22mm

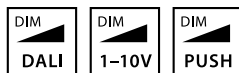

SEC	250mA	300mA	350mA	400mA	450mA	500mA	550mA	600mA	650mA	700mA
Pout	28W	34W	39W	45W	50W	56W	60W	60W	60W	60W

730091 250...700mA 28...60W 139.00 CHF

Alle Preise excl. MwSt. und VRG.

Multi LED Konverter

MINI JOLLY LC

(für kleine Ströme)



Schutzart	IP 20
Primärseitig	110-240V AC 50/60Hz
Umgebungstemp.	-25 – 45°C
Messpunkt tc	75°C
Dimmbar	DALI
Abmessungen	111 × 52 × 22mm



SEC	100mA	140mA	180mA	220W	260W	300mA	340mA	380mA	24V DC
Pout	5.3W	7.5W	9.5W	12W	14W	16W	18W	20W	9W

730092 100...380mA 24V DC 5.3...20W 89.00 CHF

Alle Preise excl. MwSt. und VRG.

Multi LED Konverter

MINI JOLLY



Schutzart	IP 20
Primärseitig	110-240V AC 50/60Hz
Umgebungstemp.	-25 – 45°C
Messpunkt tc	75°C
Dimmbar	DALI
Abmessungen	111 × 52 × 22mm



SEC	250mA	350mA	400mA	450mA	500mA	550mA	600mA	700mA	24V DC
Pout	10W	15W	17W	19W	20W	20W	20W	20W	16W

730040 250...700mA 24V DC 10...20W 69.00 CHF

Alle Preise excl. MwSt. und VRG.

Multi DALI / 1-10V / Push DIM LED Konverter MAXI JOLLY SLIM HV

(mit höherer Leistung)

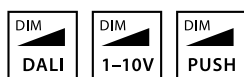

Schutzart	IP 20
Primärseitig	220-240V AC 50/60Hz
Umgebungstemp.	-25 – 45°C
Messpunkt tc	70/80°C
Dimmbar	DALI / 1-10V / Push DIM
Abmessungen	280 × 40 × 22mm

SEC Pout	350mA	500mA	550mA	700mA	850mA	900mA	1050mA	58V DC
	25W	35W	39W	50W	60W	60W	60W	60W

730056 250...700mA 58V DC 30...60W 155.00 CHF

Alle Preise excl. MwSt. und VRG.

Multi DALI LED Konverter

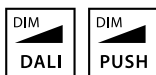

Schutzart	IP 20
Primärseitig	220-240V AC 50/60Hz
Umgebungstemp.	-20 – 45°C
Messpunkt tc	75°C
Dimmbar	DALI / Push DIM
Abmessungen	150 × 52 × 28mm

SEC Pout	350mA	500mA	700mA	900mA	12V DC	24V DC
	15W	20W	20W	20W	10W	20W

730060 350...900mA 12...24V DC 10...20W 69.00 CHF

Alle Preise excl. MwSt. und VRG. Solange der Vorrat reicht

Multi DALI LED Konverter

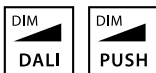

Schutzart	IP 20
Primärseitig	220-240V AC 50/60Hz
Umgebungstemp.	-20 – 45°C
Messpunkt tc	80°C
Dimmbar	DALI / Push DIM
Abmessungen	124 × 79.2 × 30mm

SEC Pout	350mA	500mA	700mA	900mA	12V DC	24V DC
	18W	26W	36W	40W	10.5W	21.5W

730061 350...900mA 12...24V DC 10.5...40W 98.00 CHF

Alle Preise excl. MwSt. und VRG. Solange der Vorrat reicht

Multi DALI / Push DIM LED Konverter 2 Kanal (separat steuerbar)

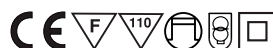
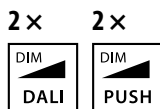

Schutzart	IP 20
Primärseitig	220-240V AC 50/60Hz
Umgebungstemp.	-20 – 45°C
Messpunkt tc	80°C
Dimmbar	DALI / Push DIM
Abmessungen	220 × 58 × 42mm

SEC Pout	350mA	500mA	700mA	900mA	12V DC	24V DC
	20W	26W	30W	23.5W	10.5W	21W

730062 2 × 350...900mA 2 × 12...24V DC 2 × 10.5...30W 138.00 CHF

Alle Preise excl. MwSt. und VRG. Solange der Vorrat reicht

Multi / Push DIM oder 1-10V LED Konverter



Schutzart	IP 20
Primärseitig	200-240V AC 50/60Hz
Umgebungstemp.	-30 – 40/50°C
Messpunkt tc	85°C
Dimmbar	DALI / Push DIM oder 1-10V
Abmessungen	105 × 68 × 23mm

SEC	350mA	500mA	600mA	700mA	900mA	1050mA
Pout	18W	25W	25W	25W	25W	25W

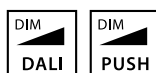

730029 **350...1050mA** **18...25W** **78.00 CHF**



730035 **350...1050mA** **18...25W** **89.00 CHF**

Alle Preise excl. MwSt. und VRG. Solange der Vorrat reicht

Multi / Push DIM oder 1-10V LED Konverter



Schutzart	IP 20
Primärseitig	200-240V AC 50/60Hz
Umgebungstemp.	-30 – 40/50°C
Messpunkt tc	90°C
Dimmbar	DALI / Push DIM oder 1-10V
Abmessungen	123.5 × 81.5 × 23mm

SEC	350mA	500mA	600mA	700mA	900mA	1050mA
Pout	35W	40W	40W	40W	40W	42W

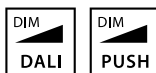

730027 **350...1050mA** **35...42W** **98.00 CHF**



730037 **350...1050mA** **35...42W** **98.00 CHF**

Alle Preise excl. MwSt. und VRG. Solange der Vorrat reicht

Multi / Push DIM oder 1-10V LED Konverter



Schutzart	IP 20
Primärseitig	200-240V AC 50/60Hz
Umgebungstemp.	-30 – 40/50°C
Messpunkt tc	90°C
Dimmbar	DALI / Push DIM
Abmessungen	123.5 × 81.5 × 23mm

SEC	500mA	600mA	700mA	900mA	1050mA	1400mA
Pout	45W	54W	60W	60W	60W	58W

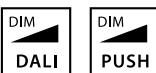

730028 **500...1400mA** **45...60W** **128.00 CHF**



730038 **500...1400mA** **45...60W** **138.00 CHF**

Alle Preise excl. MwSt. und VRG. Solange der Vorrat reicht

Multi / Push Dim LED Konverter

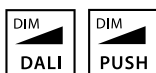
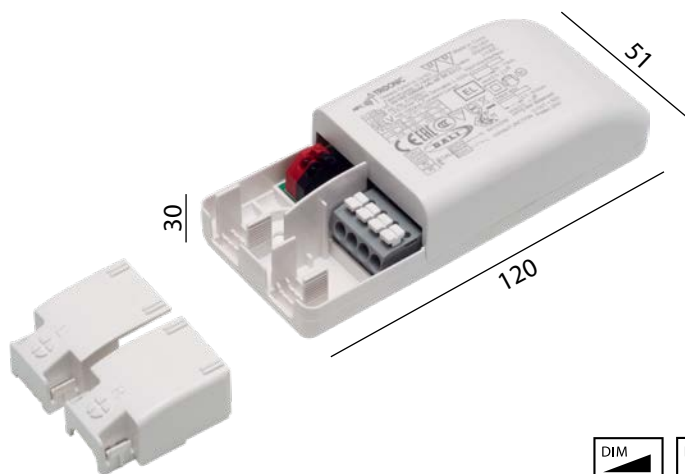

Schutzart	IP 20
Primärseitig	220-240V AC 50/60Hz
Umgebungstemp.	-25 – 50°C
Messpunkt tc	75°C
Dimmbar	DALI / Push DIM
Abmessungen	120 × 51 × 30mm

SEC	Pout	NFC))))
Konstantstrom		
100mA	4.4W	In 1mA-Schritten einstellbar zwischen 100 – 1.050mA mit DALI oder NFC (Smatphone oder Panel)
200mA	8.8W	
350mA	15.4W	
500mA	18W	
700mA	18W	
1050mA	18W	

730110-350	350mA (voreingestellt)	15.4W	46.00 CHF
730110-500	500mA (voreingestellt)	18W	46.00 CHF
730110	100...1050mA	4.4...18W	42.00 CHF

Alle Preise excl. MwSt. und VRG.

500mA / Push DIM LED Konverter

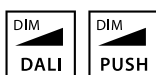
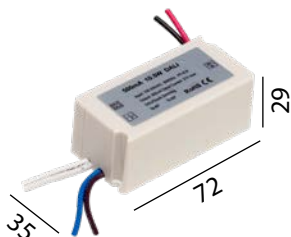

Schutzart	IP 20
Primärseitig	100-240V AC 50/60Hz
Umgebungstemp.	-20 – 40°C
Messpunkt tc	95°C
Dimmbar	DALI / Push DIM
Abmessungen	72 × 35 × 29mm

Impuls: an / aus
Halten: dimmen

Reset durch doppelten Impuls

730070	500mA 3-10.5W	52.00 CHF
---------------	----------------------	------------------

Alle Preise excl. MwSt. und VRG.

Multi / Push Dim LED Konverter

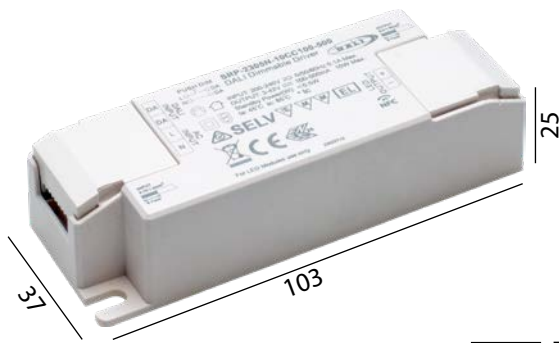

Schutzart	IP 20
Primärseitig	220-240V AC 50/60Hz
Umgebungstemp.	-25 – 45°C
Messpunkt tc	85°C
Dimmbar	DALI / Push DIM
Abmessungen	103 × 37 × 25mm

SEC	Pout	NFC)))
Konstantstrom		
100mA	4.2W	In 1mA-Schritten einstellbar zwischen 100 – 500mA mit NFC (Smatphone oder Panel)
200mA	8.4W	
350mA	11W	
500mA	10W	

730115-350	350mA (voreingestellt)	11W
730115-500	500mA (voreingestellt)	10W
730115	100...500mA	4.2...10W

Alle Preise excl. MwSt. und VRG.

Multi / Push Dim LED Konverter



Schutzart	IP 20
Primärseitig	220-240V AC 50/60Hz
Umgebungstemp.	-25 – 45°C
Messpunkt tc	85°C
Dimmbar	DALI / Push DIM
Abmessungen	145 × 46 × 31mm

SEC	Pout	NFC)))
Konstantstrom		
500mA	29W	In 1mA-Schritten einstellbar zwischen 500 – 1400mA mit NFC (Smatphone oder Panel)
700mA	41W	
900mA	48W	
1200mA	51W	
1400mA	45W	

730120-500	500mA (voreingestellt)	29W	CHF
730120-700	700mA (voreingestellt)	41W	CHF
730120	500...1400mA	29...45W	129.00 CHF

Alle Preise excl. MwSt. und VRG.

Tastenkoppler 4CH zur DALI Steuerung

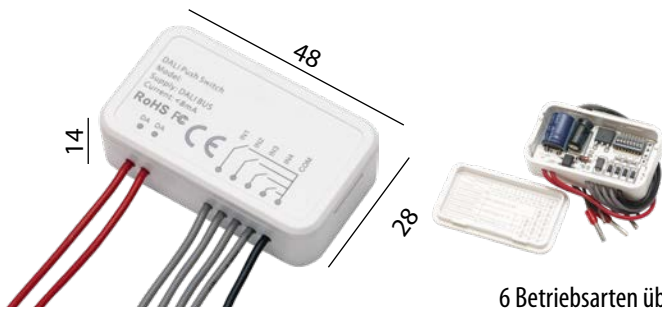

Schutzart	IP20
Stromversorgung	DALI-Spannung 9.5 V - 22.5 V, typisch 16 V
Abmessungen	48 × 28 × 14mm

Tastenkoppler mit 4 Eingängen zum Anschluss von handelsüblichen potentialfreien Tastern.

Maximale Leitungslänge der Taster Anschlüsse 15cm

6 Betriebsarten über Dipschalter einstellbar:

- Steuert 4 Adressen / Gruppen über 4 Einzeltaster: T1-T4: an / aus / dim
- Steuert 2 Adressen / Gruppen über 4 Einzeltaster: T1/T3: an / heller & T2/T4: aus / dunkler
- Steuert 4 Szenen über 4 Einzeltaster
- Broadcast Modus: an / aus / dim

73176

4CH Tastenkoppler für DALI Netzwerk

89.00 CHF

Alle Preise excl. MwSt. und VRG.

Sonderrabatt

Gruppensteuerung über DALI Netzwerk mit Taster

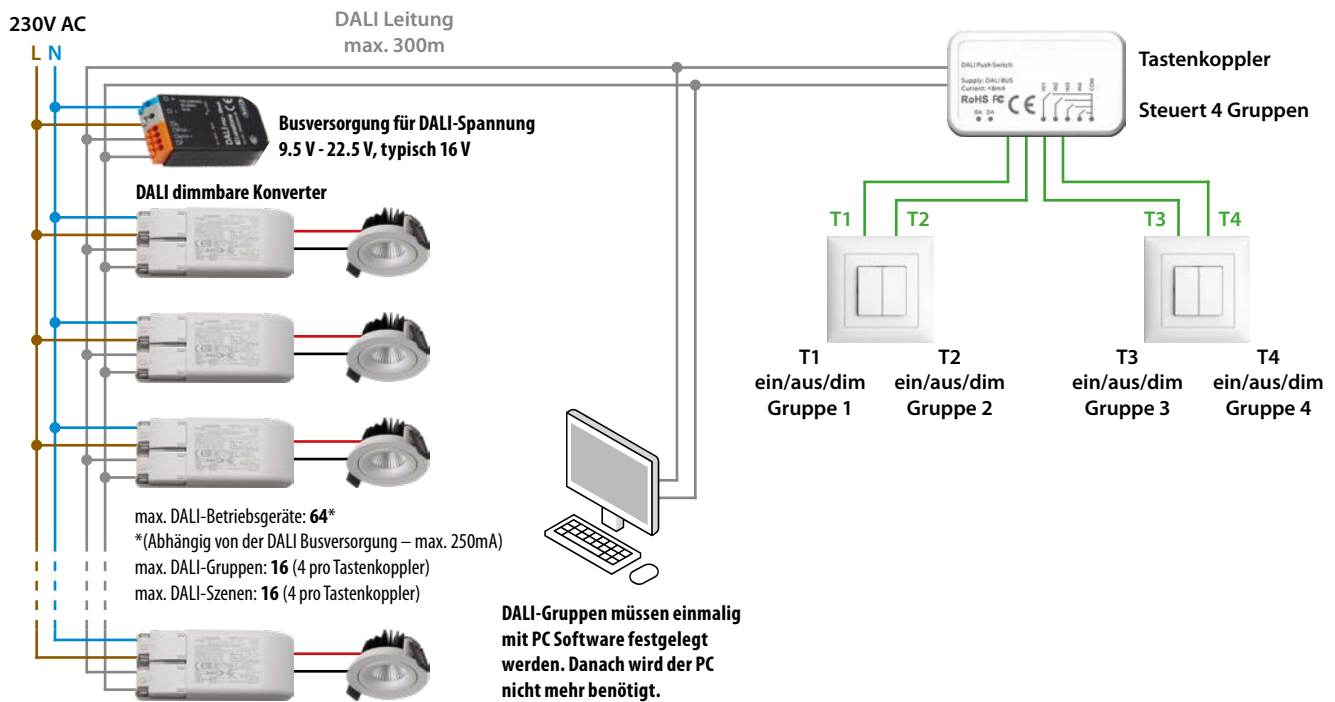

Bluetooth Steuermodul für bis 32 DALI Geräte

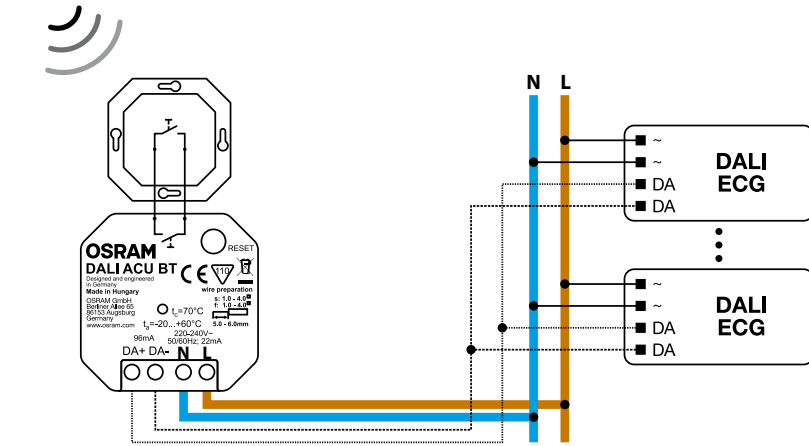
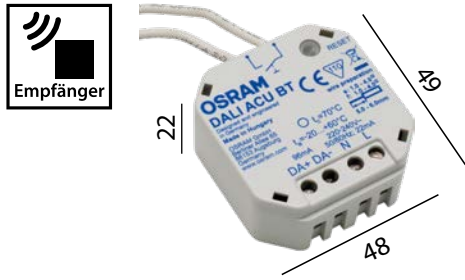

Schutzart	IP20
Stromversorgung	230 V
Abmessungen	48 × 49 × 22mm

- Steuern der Beleuchtung via Smartphone oder Taster
- Plug and Play: Basisfunktionen ohne App verfügbar
- DALI Dimmung für bis 32 DALI Leuchten oder Geräte.
- Länge der DALI Leitung max. 300m

! Nicht kompatibel mit CASAMBI !



für Android



für iOS

544819

Steuermodul für bis 32 DALI Geräte

103.00 CHF

Alle Preise excl. MwSt. und VRG.

Sonderrabatt

Phasenabschnitt Dimmer 3-25W mit Steuerung

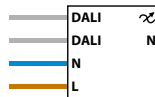
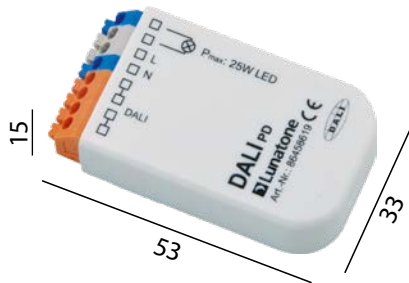

Schutzart	IP20
Stromversorgung	230 V
Abmessungen	53 × 33 × 15mm

25W Phasenabschnitt Dimmer, der über ein DALI Signal gesteuert werden kann.

73160

3-25W Phasenabschnitt Dimmer mit DALI Steuerung

108.00 CHF

Alle Preise excl. MwSt. und VRG.

Sonderrabatt

Phasenabschnitt Dimmer 10-300W mit Steuerung



Schutzart	IP20
Stromversorgung	230 V
Abmessungen	130 × 30 × 22mm

300W Phasenabschnitt Dimmer, der über ein DALI Signal gesteuert werden kann.

73162

10-300W Phasenabschnitt Dimmer mit DALI Steuerung

176.00 CHF

Alle Preise excl. MwSt. und VRG.

Sonderrabatt

LED Unterputz-Dimmer 5-150W

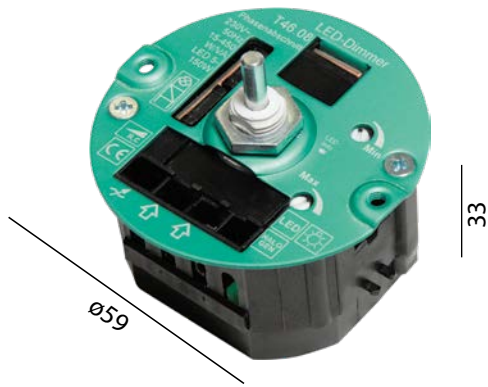

Schutzart	IP 20
Primärseitig	230V AC 50Hz
Abmessungen	ø59 × 33mm

Drehdimmer mit Druck-Wechsel-Schalter.

Min- und Maximalhelligkeit einstellbar.

80360	LED Unterputz-Dimmer 5-150W (15-450W bei nicht LED)	# 138.00 CHF
Alle Preise excl. MwSt. und VRG.		# Sonderrabatt

LED Schnurdimmer 3-55W



Schutzart	IP 20
Primärseitig	230V AC 50Hz
Abmessungen	ø75 × 26mm

Ein / Aus / Dimmen über Druck
(Hand- und Fussbedienung möglich)

Min- und Maximalhelligkeit einstellbar.



80362-WS	<input type="checkbox"/> weiss	LED Schnurdimmer 3-55W (5-150W bei nicht LED)	# 94.00 CHF
80362-SZ	<input checked="" type="checkbox"/> schwarz	LED Schnurdimmer 3-55W (5-150W bei nicht LED)	# 94.00 CHF
80362-TR	<input type="checkbox"/> transparent	LED Schnurdimmer 3-55W (5-150W bei nicht LED)	# 94.00 CHF

Alle Preise excl. MwSt. und VRG.

Sonderrabatt

LED Schnurdimmer 3-35W



Schutzart	IP 20
Primärseitig	230V AC 50Hz
Abmessungen	81 × 32 × 23mm

Ein / Aus / Dimmen durch Tastbetätigung

Min- und Maximalhelligkeit einstellbar.



80365-WS	<input type="checkbox"/> weiss	LED Schnurdimmer 3-35W (5-100W bei nicht LED)	# 92.00 CHF
80365-SZ	<input checked="" type="checkbox"/> schwarz	LED Schnurdimmer 3-35W (5-100W bei nicht LED)	# 92.00 CHF
80365-TR	<input type="checkbox"/> transparent	LED Schnurdimmer 3-35W (5-100W bei nicht LED)	# 92.00 CHF

Alle Preise excl. MwSt. und VRG.

Sonderrabatt

LED Schnurdimmer 3-35W

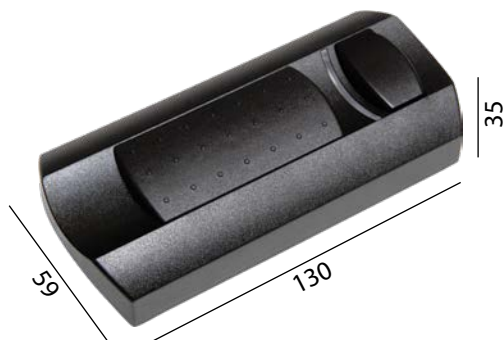

Schutzart	IP 20
Primärseitig	230V AC 50Hz
Abmessungen	130 × 59 × 35mm



Ein / Aus über separaten Schalter
Dimmen über Schieberegler

Minimalhelligkeit einstellbar.



80370-SZ ■ schwarz LED Schnurdimmer **3-35W** (7-110W bei nicht LED) # **72.00 CHF**

80370-TR □ transparent LED Schnurdimmer **3-35W** (7-110W bei nicht LED) # **72.00 CHF**

Alle Preise excl. MwSt. und VRG.

Sonderrabatt

LED Schnurdimmer 3-150W

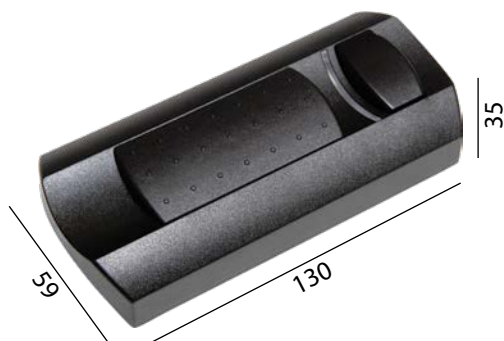

Schutzart	IP 20
Primärseitig	230V AC 50Hz
Abmessungen	130 × 59 × 35mm



Ein / Aus über separaten Schalter
Dimmen über Schieberegler

Minimalhelligkeit einstellbar.



80373-SZ ■ schwarz LED Schnurdimmer **3-150W** (20-500W bei nicht LED) # **78.00 CHF**















80373-TR □ transparent LED Schnurdimmer **3-150W** (20-500W bei nicht LED) # **78.00 CHF**

Alle Preise excl. MwSt. und VRG.

Sonderrabatt

Planungshilfe Konfigurationstabelle

Konfigurationstabelle für die Anzahl der LED Retrofit mit dimmbaren Konvertern

					
		740040 740041 6.2W 350mA	740042 740043 9.2W 500mA	740044 740045 12.4W 450mA	740025 15W 350mA
	730093 Dimmbar: DALI / PUSH	2	2	1	1
	730094 Dimmbar: DALI / PUSH	2	2	1	1
	730040 Dimmbar: DALI	2	2	1	1
	730042 Dimmbar: 1-10V / PUSH	2	2	—	1
	730041 Dimmbar: DALI	2	2	—	1
	730043 Dimmbar: 1-10V / PUSH	3	2	2	1
	730066 Dimmbar: DALI / 1-10V / PUSH	4	3	—	1
	730091 Dimmbar: DALI / 1-10V / PUSH	6	6	4	2
	730029 Dimmbar: DALI / PUSH	2	2	—	1
	730035 Dimmbar: 0-10V	2	2	—	1
	730027 Dimmbar: DALI / PUSH	5	4	—	2
	730037 Dimmbar: 0-10V	5	4	—	2
	730028 Dimmbar: DALI / PUSH	—	4	—	—
	730038 Dimmbar: 0-10V	—	4	—	—
	730060 Dimmbar: DALI / PUSH	2	2	—	1
	730061 Dimmbar: DALI / PUSH	2	2	—	1
	730062 Dimmbar: DALI / PUSH	2 × 3	2 × 2	—	2 × 1



Power LED niemals parallel schalten!!



Power LED immer ohne Stromzufuhr anschliessen!!



richtig

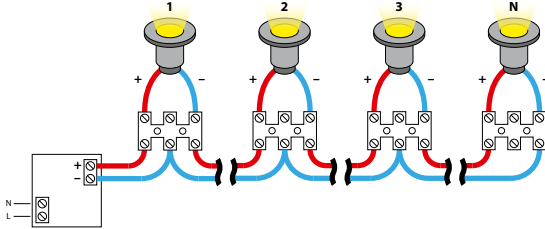

richtig

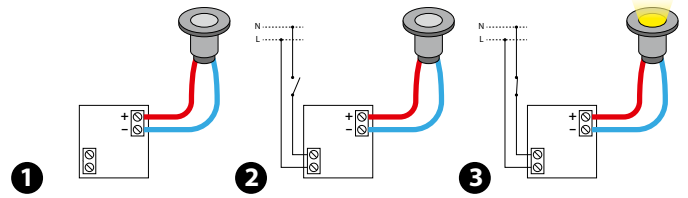

falsch

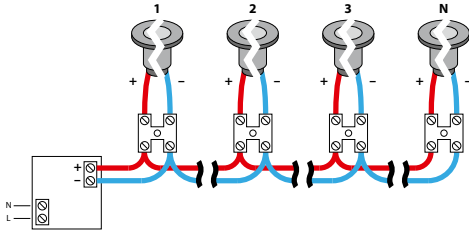

falsch

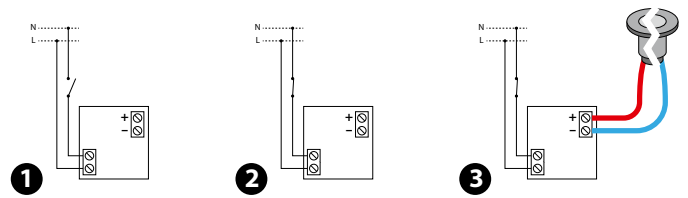

230V 12W LED Modul

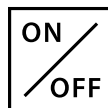
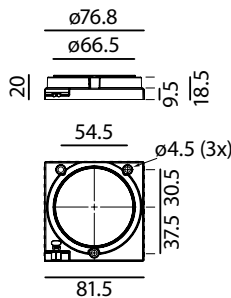
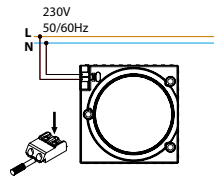

28000486

3000K 1024 lm

98.00 CHF



Zubehör

28000420 Adapterplatte (ersetzt keinen Kühlkörper)

TPCM585-ZHA Wärmeleitende Klebefolie

Alle Preise excl. MwSt. und VRG.



Spannung	230V AC, 50Hz (nicht dimmbar)
Schutzart	IP 00
Schutzklasse:	Wenn LED Module in eine Leuchte mit Schutzklasse I eingebaut werden, müssen Kühlkörper und Leuchtgehäuse geerdet werden.
LED	Triodonic
Leistung	12W
Betriebstemperatur ta	-30 ... +65° C
tp	65° C
Farbwiedergabe Ra	80
Abstrahlwinkel	80°
Massangaben	81.5 × 81.5mm

Eine thermische Verbindung zwischen LED Modul und Kühlkörper mittels Wärmeleitpaste oder wärmeleitender Klebefolie ist zwingend notwendig. Das LED Modul muss zusätzlich auf dem Kühlkörper mit M3 Schrauben befestigt werden, um die thermische Verbindung zu optimieren.

CASAMBI BLUETOOTH 1-150W Phasenabschnitt Dimmer



Schutzart	IP20
Stromversorgung	230 V
Abmessungen	37 × 41 × 14mm

230V AC 1-150W Phasenabschnitt Dimmer mit Casambi über Smartphone oder Tablet Steuerbar.

Kostenlose App von CASAMBI (Apple / Android)

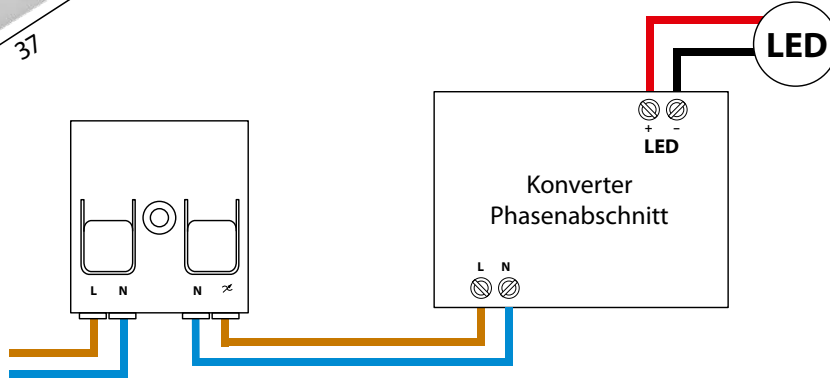

80337

1-150W BLUETOOTH Phasenabschnitt Dimmer

115.00 CHF

Alle Preise excl. MwSt. und VRG.

Sonderrabatt

CASAMBI BLUETOOTH 4-300W Phasenabschnitt Dimmer



Schutzart	IP20
Stromversorgung	230 V
Abmessungen	37 × 41 × 14mm

230V AC 3-300W Phasenabschnitt Dimmer mit Casambi über Smartphone oder Tablet Steuerbar.

Programmierbarer Tasteingang, kann mit Funktion belegt werden.

Kostenlose App von CASAMBI (Apple / Android)

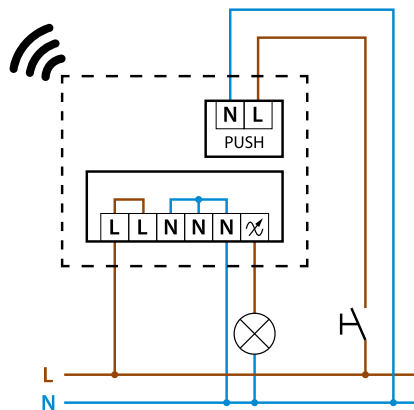

4-300W BLUETOOTH Phasenabschnitt Dimmer

CHF

Alle Preise excl. MwSt. und VRG.

Sonderrabatt

CASAMBI BLUETOOTH 1-10V Steuermodul

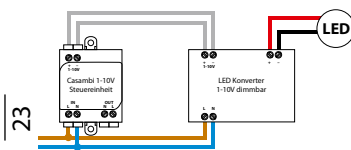

Schutzart	IP20
Stromversorgung	230 V
Abmessungen	31 × 52 × 23mm

230V AC 1-10V Steuermodul mit Casambi über Smartphone oder Tablett Steuerbar.

Kostenlose App von CASAMBI (Apple / Android)

80325

1-10V Steuermodul

139.00 CHF

Alle Preise excl. MwSt. und VRG.

Sonderrabatt

CASAMBI Schaltrelais für Wandeinbau

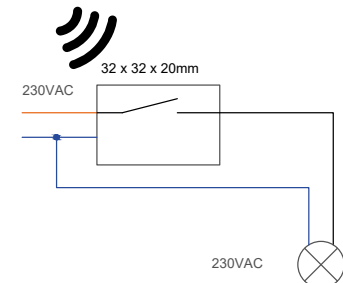
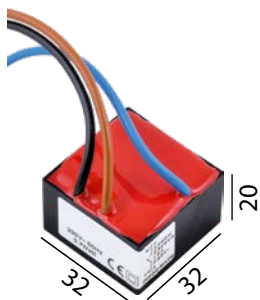

Schutzart	IP44
Stromversorgung	230 V
Abmessungen	32 × 32 × 20mm

230V AC 10A On/Off Schaltrelais 1 Pol. Schliesser mit Casambi über Smartphone oder Tablett Steuerbar. Für Elemente oder Leuchten.

80336

Schaltrelais für Wandeinbau

126.00 CHF

Alle Preise excl. MwSt. und VRG.

Sonderrabatt

CASAMBI BLUETOOTH Steuermodul für DALI



Schutzart	IP20
Stromversorgung	230 V
Abmessungen	31 × 52 × 23mm

230V AC DALI Steuermodul mit Casambi über Smartphone oder Tablet Steuerbar. Dimmung für DALI Leuchten oder Geräte.
Kostenlose App von CASAMBI (Apple / Android)

Sendet an die DALI-Adressen: 0, 1, 2, 3 (abhängig von den Kanälen) Anpassung der Adressierung per App nicht möglich. DALI-Gerät muss diese Adressen voreingestellt haben.

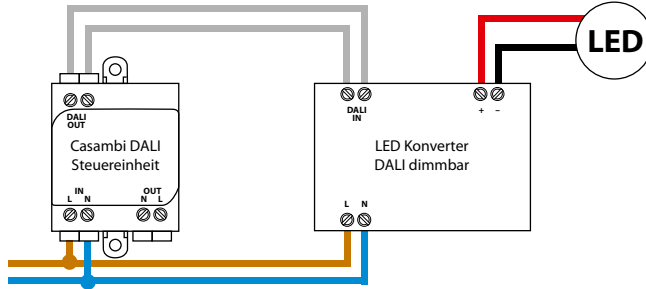

80330-01	Steuermodul für 1 Gerät/Leuchte mit 1 DALI Kanal	# 149.00 CHF
80330-02	Steuermodul für 1 Gerät/Leuchte mit 2 DALI Kanälen	# 149.00 CHF
80330-03	Steuermodul für 1 Gerät/Leuchte mit 3 DALI Kanälen	# 149.00 CHF
80330-04	Steuermodul für 1 Gerät/Leuchte mit 4 DALI Kanälen	# 149.00 CHF

Alle Preise excl. MwSt. und VRG.

Sonderrabatt

CASAMBI DALI Steuermodul 1 Kanal (max. 50 DALI Geräte)

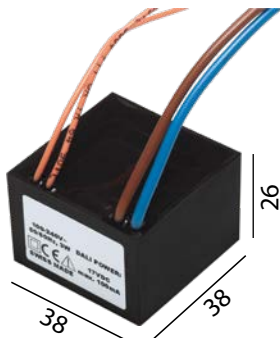

Schutzart	IP20
Stromversorgung	230 V
Abmessungen	38 × 38 × 26mm

230V AC DALI Steuermodul mit Casambi über Smartphone oder Tablet Steuerbar.
 DALI Dimmung für bis 50 DALI Leuchten oder Geräte.

Kostenlose App von CASAMBI (Apple / Android)

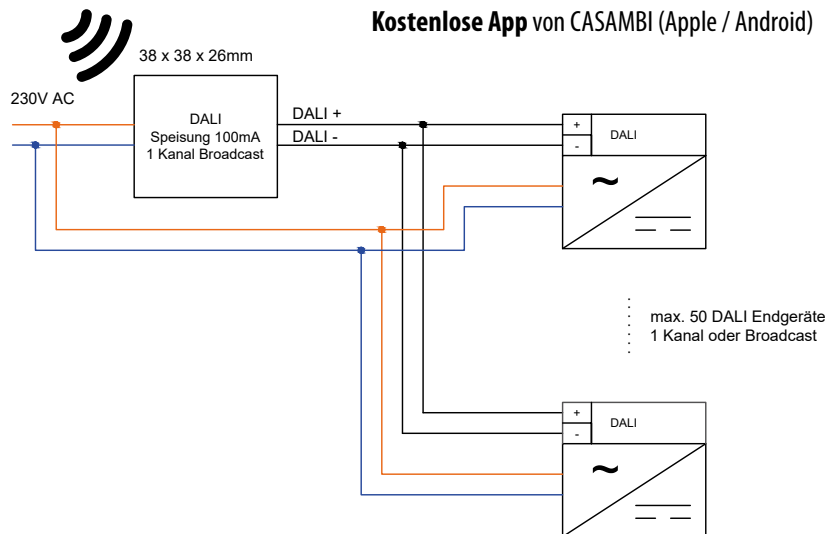

80339	Steuermodul für bis 50 DALI Geräte	# 168.00 CHF
-------	------------------------------------	--------------

Alle Preise excl. MwSt. und VRG.

Sonderrabatt

CASAMBI Steuermodul für bis 2 × 15 DALI Geräte

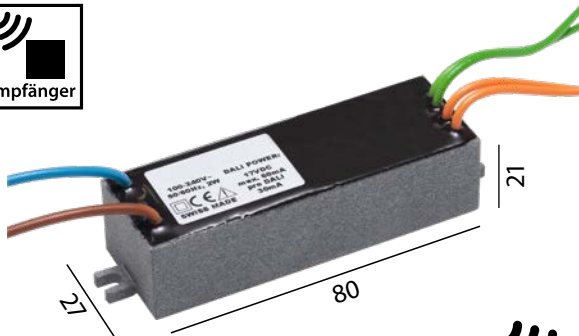

Schutzart	IP20
Stromversorgung	230 V
Abmessungen	80 × 27 × 21mm



230V AC DALI Steuermodul mit Casambi über Smartphone oder Tablett Steuerbar.
DALI Dimmung für bis 2 × 15 DALI Leuchten oder Geräte.

Kostenlose App von CASAMBI (Apple / Android)

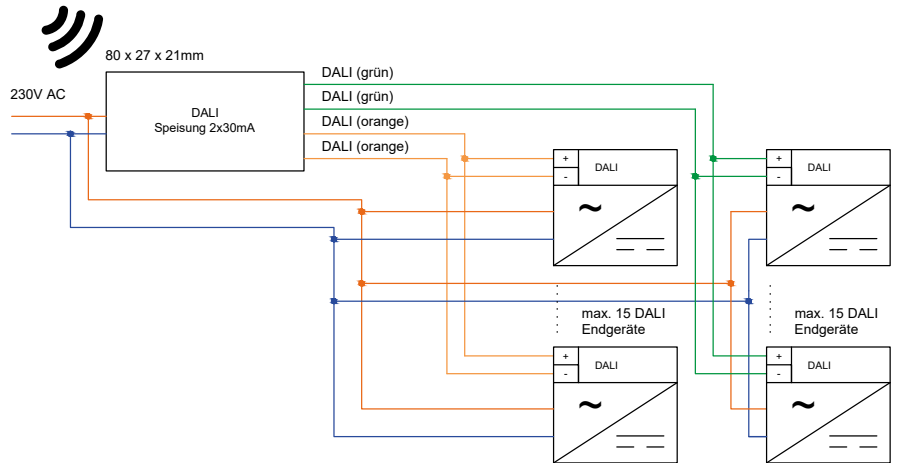

80334

Steuermodul für bis 2 × 15 DALI Geräte

206.00 CHF

Alle Preise excl. MwSt. und VRG.

Sonderrabatt

Multi LED Konverter PROFESSIONALE CASAMBI



Schutzart	IP 20
Primärseitig	200-240V AC 50/60Hz
Umgebungstemp.	-25 – 45°C
Messpunkt tc	85°C
Dimmbar	CASAMBI / Push DIM
Abmessungen	146.5 × 44 × 30mm

SEC	Pout	Dip-Schalter			
		1	2	3	4
Konstantstrom					
300mA	16W	-	-	-	-
350mA	18W	on	-	-	-
400mA	21W	-	on	-	-
450mA	24W	on	on	-	-
500mA	27W	-	-	on	-
550mA	29W	on	-	on	-
600mA	32W	-	on	on	-
650mA	35W	on	on	on	-
700mA	38W	-	-	-	on
750mA	38W	on	-	-	on
800mA	38W	-	on	-	on
850mA	38W	on	on	-	on
900mA	38W	-	-	on	on
950mA	38W	on	-	on	on
1000mA	38W	-	on	on	on
1050mA	38W	on	on	on	on



73155

300...1050mA

16...38W

168.00 CHF

Alle Preise excl. MwSt. und VRG.

CASAMBI Multi 150...400mA LED Konverter

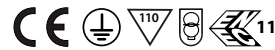
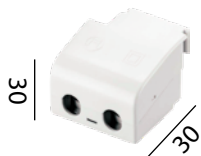
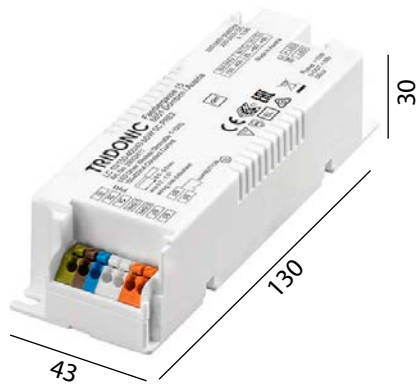

Schutzart	IP 20
Primärseitig	220-240V AC 50/60Hz
Umgebungstemp.	-25 – 65°C
Messpunkt tc	80°C
Dimmbar	CASAMBI / *Taster potentialfrei
Abmessungen	130 × 43 × 30mm



* Tastereingang für An / Aus / Dim Funktion, Gruppen- und Szenensteuerung, über CASAMBI App programmierbar. Mehrere Geräte über einen Tastereingang steuerbar.

I-Select 2 Plug	Offen	200MA BL	250MA BL	300MA BL	350MA BL	Kurzschluss
SEC	150mA	200mA	250mA	300mA	350mA	400mA
Pout	6W	8W	10W	10W	10W	10W

28002411	150...400mA	6...10W	131.00 CHF
28001699	Zugentlastung Primär		2.00 CHF
28001574	Zugentlastung Sekundär		4.00 CHF



I-Select 2 Plug für Ausgangstromauswahl (Weitere auf Homepage TRIDONIC)			
28001110	I-Select 2 Plug 350MA BL – Blau (14.30 kΩ)		1.00 CHF

Alle Preise excl. MwSt. und VRG.

CASAMBI Multi 250...700mA LED Konverter

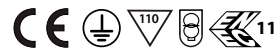
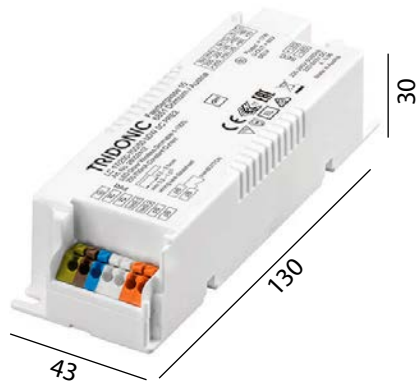

Schutzart	IP 20
Primärseitig	220-240V AC 50/60Hz
Umgebungstemp.	-25 – 55/60°C
Messpunkt tc	75/80°C
Dimmbar	CASAMBI / *Taster potentialfrei
Abmessungen	130 × 43 × 30mm



* Tastereingang für An / Aus / Dim Funktion, Gruppen- und Szenensteuerung, über CASAMBI App programmierbar. Mehrere Geräte über einen Tastereingang steuerbar.

I-Select 2 Plug	Offen	300MA BL	350MA BL	400MA BL	450MA BL
SEC	250mA	300mA	350mA	400mA	450mA
Pout	12.5W	15W	17.2W	17.2W	17.1W
I-Select 2 Plug	500MA BL	550MA BL	600MA BL	650MA BL	Kurzschluss
SEC	500mA	550mA	600mA	650mA	700mA
Pout	17W	17.1W	16.8W	16.9W	16.8W

28002412	250...700mA	12.5...17.2W	133.00 CHF
28001699	Zugentlastung Primär		2.00 CHF
28001574	Zugentlastung Sekundär		4.00 CHF



I-Select 2 Plug für Ausgangstromauswahl (Weitere auf Homepage TRIDONIC)			
28001110	I-Select 2 Plug 350MA BL – Blau (14.30 kΩ)		1.00 CHF
28001114	I-Select 2 Plug 500MA BL – Blau (10.00 kΩ)		1.00 CHF

Alle Preise excl. MwSt. und VRG.

CASAMBI Multi 350...1050mA LED Konverter

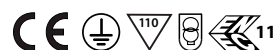
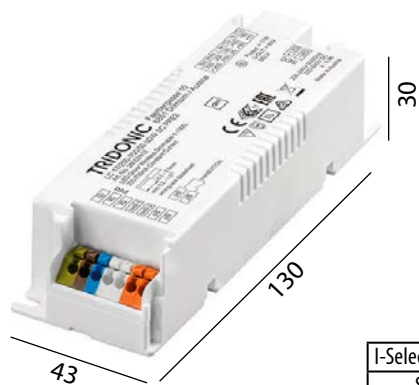

Schutzart	IP 20
Primärseitig	220-240V AC 50/60Hz
Umgebungstemp.	-25 – 55/60°C
Messpunkt tc	75°C
Dimmbar	CASAMBI / *Taster potentialfrei
Abmessungen	130 × 43 × 30mm



* Tastereingang für An / Aus / Dim Funktion, Gruppen- und Szenensteuerung, über CASAMBI App programmierbar. Mehrere Geräte über einen Tastereingang steuerbar.

I-Select 2 Plug	Offen	400MA BL	450MA BL	500MA BL	550MA BL	600MA BL	650MA BL	700MA BL
SEC	350mA	400mA	450mA	500mA	550mA	600mA	650mA	700mA
Pout	17.5W	20W	22.5W	25W	24.8W	24.6W	24.7W	24.5W
I-Select 2 Plug	Offen	800MA BL	850MA BL	900MA BL	950MA BL	1000MA BL	Kurzschluss	
SEC	750mA	800mA	850mA	900mA	950mA	1000mA	1050mA	
Pout	24.8W	24.8W	24.7W	24.3W	24.7W	25W	24.2W	

28002413	350...1050mA	17.5...25W	140.00 CHF
28001699	Zugentlastung Primär		2.00 CHF
28001574	Zugentlastung Sekundär		4.00 CHF



I-Select 2 Plug für Ausgangstromauswahl (Weitere auf Homepage TRIDONIC)

28001114	I-Select 2 Plug 500MA BL – Blau (10.00 kΩ)	1.00 CHF
28001118	I-Select 2 Plug 700MA BL – Blau (7.15 kΩ)	1.00 CHF
28001122	I-Select 2 Plug 900MA BL – Blau (5.62 kΩ)	1.00 CHF

Alle Preise excl. MwSt. und VRG.

CASAMBI Multi 500...1400mA LED Konverter

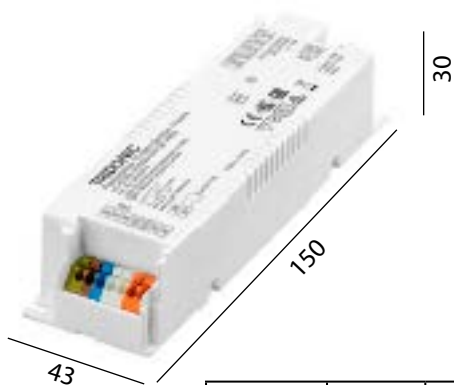

Schutzart	IP 20
Primärseitig	220-240V AC 50/60Hz
Umgebungstemp.	-25 – 50°C
Messpunkt tc	80/85°C
Dimmbar	CASAMBI / *Taster potentialfrei
Abmessungen	150 × 43 × 30mm



* Tastereingang für An / Aus / Dim Funktion, Gruppen- und Szenensteuerung, über CASAMBI App programmierbar. Mehrere Geräte über einen Tastereingang steuerbar.

I-Select 2 Plug	Offen	550MA BL	600MA BL	650MA BL	700MA BL	750MA BL	800MA BL	850MA BL	900MA BL	950MA BL
SEC	500mA	550mA	600mA	650mA	700mA	750mA	800mA	850mA	900mA	950mA
Pout	25W	27.5W	30W	32.5W	35W	37.5W	40.0W	42.5W	45W	45W
I-Select 2 Plug	Offen	1000MA BL	1050MA BL	1100MA BL	1150MA BL	120MA BL	1250MA BL	1300MA BL	1350MA BL	Kurzschluss
SEC	1000mA	1050mA	1100mA	1150mA	1200mA	1250mA	1300mA	1350mA	1400mA	
Pout	45W	45W	45W	45W	45W	45W	45W	45W	44.9W	

28002414	500...1400mA	25...45W	142.00 CHF
28001699	Zugentlastung Primär		2.00 CHF
28001574	Zugentlastung Sekundär		4.00 CHF



I-Select 2 Plug für Ausgangstromauswahl (Weitere auf Homepage TRIDONIC)

28001118	I-Select 2 Plug 700MA BL – Blau (7.15 kΩ)	1.00 CHF
28001122	I-Select 2 Plug 900MA BL – Blau (5.26 kΩ)	1.00 CHF
28001128	I-Select 2 Plug 1200MA BL – Blau (4.12 kΩ)	1.00 CHF

Alle Preise excl. MwSt. und VRG.

CASAMBI BLUETOOTH 4 Kanal Einbausender



53

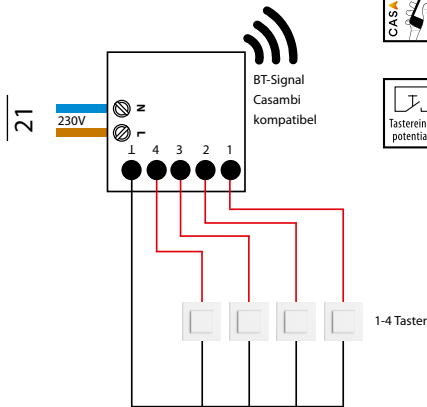

Schutzart	IP20
Stromversorgung	230 V
Abmessungen	ø53 × 21mm

230V AC Casambi Funksender für Wandschalter oder Hausautomatisierungsanlagen.

Ideal für den Einbau in Unterputzdosen.

80338

4 Kanal Einbausender

230.00 CHF

Alle Preise excl. MwSt. und VRG.

Sonderrabatt

CASAMBI 4 Kanal Einbausender für Wand-Bedientasten



40

40

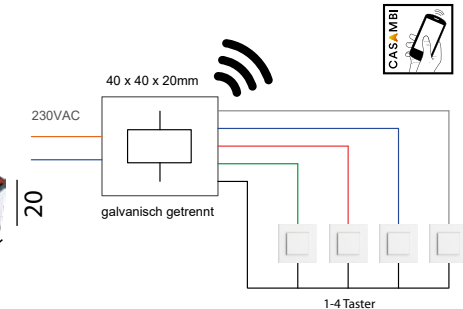

Schutzart	IP44
Stromversorgung	230 V
Abmessungen	40 × 40 × 20mm

230V AC Casambi Funksender für Wandschalter oder Hausautomatisierungsanlagen.

Ideal für den Einbau in Unterputzdosen.

80335

4 Kanal Einbausender

164.00 CHF

Alle Preise excl. MwSt. und VRG.

Sonderrabatt

CASAMBI BLUETOOTH Fernbedienung



90



Schutzart	IP20
Stromversorgung	3V Batterie CR2430
Abmessungen	90 × 90 × 18mm

Funkschalter zur Steuerung von Casambi-Geräten
Kostenlose App von CASAMBI (Apple / Android)

- 4 Tasten (heller-dunkler; warm-/kaltweiss)
- 4 frei programmierbare Tasten (Szenen, Farbe, ...)
- Programmierung erfolgt per Smartphone / Tablet
- Die Lebensdauer der Batterie hängt vom Gebrauch ab
- Zur freien Montage an der Wand, abnehmbar von magnetischer Grundplatte

80340-00

weiss

Casambi **Wandfunksender**

298.00 CHF

80340-02

schwarz

Casambi **Wandfunksender**

298.00 CHF

Alle Preise excl. MwSt. und VRG.

Sonderrabatt

EnOcean BLUETOOTH Funktaster 2 Kanäle / 1 Wipptaster

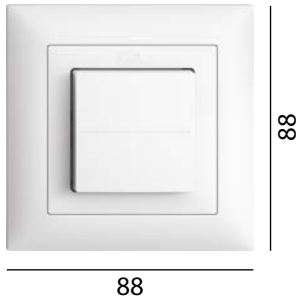

Schutzart IP20

Stromversorgung Keine Verkabelung oder Batterie benötigt

Abmessungen 88 × 88mm

- Reichweite bis 10 m im Gebäude
- Kompatibel mit CASAMBI und weiteren Drittherstellern
- Kann an die Wand aufgeschraubt oder aufgeklebt werden
- Mit NFC-Schnittstelle gemäss zur Konfiguration

374 740 000

**EnOcean Funktaster**

91.00 CHF

374 740 950

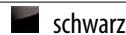
**EnOcean Funktaster**

91.00 CHF

Alle Preise excl. MwSt. und VRG.

Sonderrabatt

EnOcean BLUETOOTH Funktaster 4 Kanäle / 2 Wipptaster

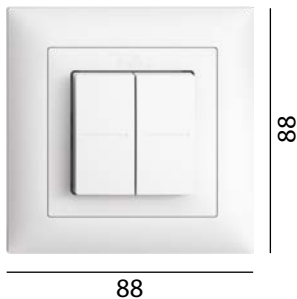

Schutzart IP20

Stromversorgung Keine Verkabelung oder Batterie benötigt

Abmessungen 88 × 88mm

- Reichweite bis 10 m im Gebäude
- Kompatibel mit CASAMBI und weiteren Drittherstellern
- Kann an die Wand aufgeschraubt oder aufgeklebt werden
- Mit NFC-Schnittstelle gemäss zur Konfiguration

374 750 000

**Funktaster**

95.00 CHF

374 750 950

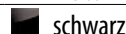
**Funktaster**

95.00 CHF

Alle Preise excl. MwSt. und VRG.

Sonderrabatt

Tischfernbedienung BLUETOOTH 4 Kanäle / 2 Wipptaster



Schutzart IP20

Abmessungen 120 × 52 × 20mm

Fernbedienung zur Steuerung von Geräten in CASAMBI-Netzwerken

Bis zu 4 programmierbare Tasten (dimmen, Szenen, Farbe, ...)

Erstprogrammierung muss per Smartphone / Tablet (Apple / Android) mit NFC-Schnittstelle und der CASAMBI-App erfolgen!

Die Energie für das Funksignal entsteht beim Drücken der Taste durch die kinetische Energie (Energy Harvesting); es wird daher keine Batterie benötigt, wartungsfrei

80341-02

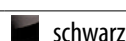
**Tischfernbedienung**

190.00 CHF

Alle Preise excl. MwSt. und VRG.

Sonderrabatt

HaloX-100

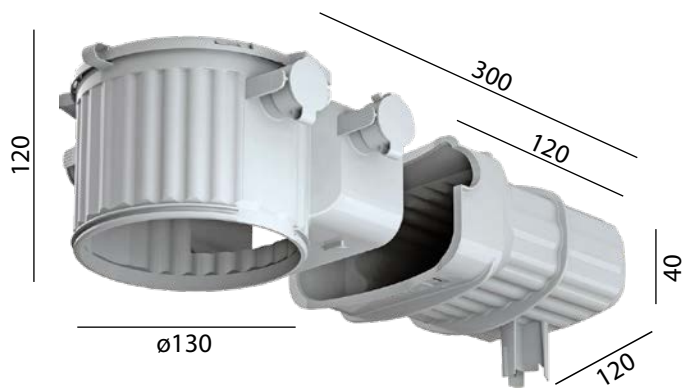

Beton-Einbaugehäuse für HV/NV-Einbauleuchten

HaloX-100 Gehäuse für Betondecken und -wände, Gehäuse und Tunnel aus Polyethylen, formbeständig bis 100°C, feuerbeständig bis 650°C, halogenfrei, schwenkbare Trennwand zwischen Gehäuse und Tunnel reduziert die Temperaturbelastung im Transformbereich.

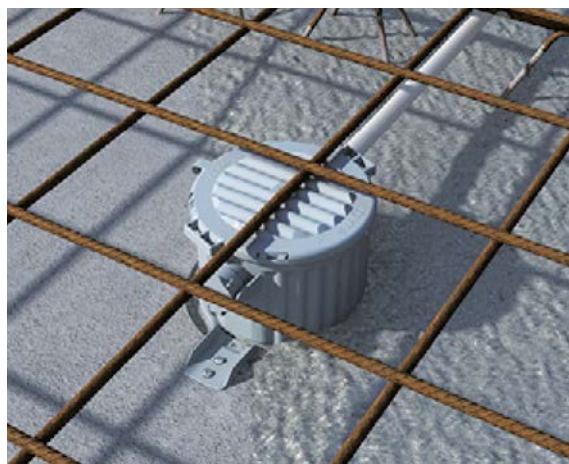

Beton-Einbaugehäuse

1281-00	HaloX-100 Betongehäuse ohne Frontdeckel / ohne Tunnel	12.00 CHF
1281-30	HaloX-100 Betongehäuse ohne Frontdeckel / mit Tunnel	29.10 CHF

Frontdeckel		Ausschnitt	Leuchtenblende min.	
1281-01	rund	ø68mm	ø75mm	7.10 CHF
1281-02	rund	ø75mm	ø87mm	7.10 CHF
1281-03	rund	ø80mm	ø92mm	7.10 CHF
1281-04	rund	ø85mm	ø97mm	7.10 CHF
1281-05	rund	ø90mm	ø102mm	7.10 CHF
1281-06	rund	ø95mm	ø107mm	7.10 CHF
1281-07	rund	ø100mm	ø112mm	7.10 CHF
1281-08	quadratisch	68x68mm	75x75mm	7.10 CHF
1281-09	quadratisch	75x75mm	82x82mm	7.10 CHF
1281-10	universal	ø40-100mm	—	7.10 CHF
1281-11	Mineralfaserplatte	ø0-100mm	—	



Verlängerungsringe

1281-21	Erhöhung der Einbautiefe um jeweils 10mm	7.10 CHF
1281-25	Erhöhung der Einbautiefe um jeweils 25mm	15.70 CHF
1281-50	Erhöhung der Einbautiefe um jeweils 50mm	16.40 CHF

Alle Preise excl. MwSt.

HaloX-180

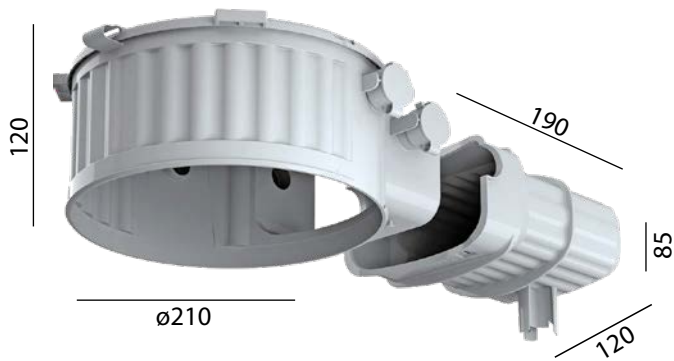

Beton-Einbaugehäuse für HV/NV-Einbauleuchten

HaloX-180 Gehäuse für Betondecken und -wände, Gehäuse und Tunnel aus Polyethylen, formbeständig bis 100°C, feuerbeständig bis 650°C, halogenfrei, schwenkbare Trennwand zwischen Gehäuse und Tunnel reduziert die Temperaturbelastung im Transformbereich.

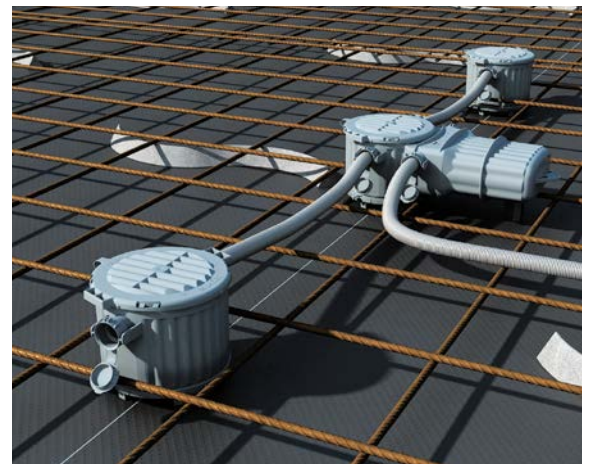

Beton-Einbaugehäuse

1282-00	HaloX-180 ohne Frontdeckel / ohne Tunnel	22.00 CHF
1282-30	HaloX-180 ohne Frontdeckel / mit Tunnel (kurz)	42.50 CHF
1282-40	HaloX-180 ohne Frontdeckel / mit Tunnel (Lang)	47.00 CHF

Frontdeckel		Ausschnitt	Leuchtenblende min.	
1282-01	rund	Ø100mm	Ø107mm	9.20 CHF
1282-02	rund	Ø110mm	Ø117mm	9.20 CHF
1282-03	rund	Ø125mm	Ø132mm	9.20 CHF
1282-04	rund	Ø145mm	Ø152mm	9.20 CHF
1282-05	rund	Ø160mm	Ø167mm	9.20 CHF
1282-06	rund	Ø180mm	Ø187mm	9.20 CHF
1282-10	universal	Ø40-180mm	—	16.50 CHF
1282-11	Mineralfaserplatte	Ø0-180mm	—	

Verlängerungsringe

1282-25	Erhöhung der Einbautiefe um jeweils 25mm	15.70 CHF
1282-50	Erhöhung der Einbautiefe um jeweils 50mm	19.70 CHF

Alle Preise excl. MwSt.



Firestop-Boxen

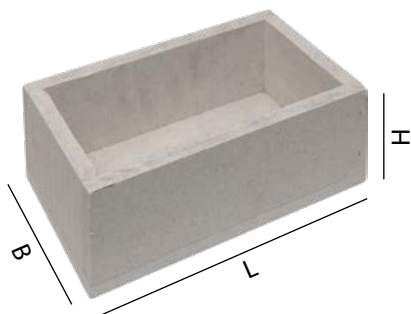

Nur bei Firestop 1 & 2 können elektronische Trafos versetzt in die Box angewendet werden. Leuchtmittel nur Alureflektor 12V oder 230V, wenn möglich nur mit 35W bestücken.

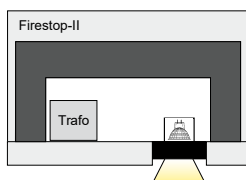

	Bezeichnung	Durchmesser	Sichtbeton	VE	
3.220-160-90	Firestop-Box 1 (15mm)	L 220 / B 160 / H 90	nein	1	32.00 CHF
3.220-220-90	Firestop-Box 2 (15mm)	L 320 / B 220 / H 90	nein	1	38.00 CHF
3.160-160-110	Firestop-Box 3 (15mm)	L 160 / B 160 / H 110	nein	1	30.00 CHF
3.220-160-110	Firestop-Box 4 (15mm)	L 260 / B 160 / H 110	nein	1	36.00 CHF
Spezialmass	Firestop-Box 5	Nach Mass	bedingt	1	Auf Anfrage

Alle Preise excl. MwSt.

Box für Wandeinbau mit Putzrahmen

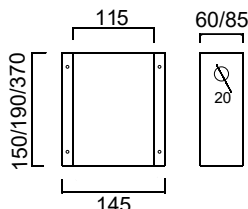
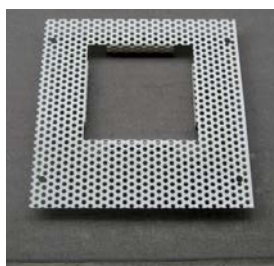

Bezeichnung	Artikel Nr.	Preis
Einbaubox 150 × 145 × 60mm	5565 Bx	36.00 CHF
Putzrahmen AS = 68 × 68mm	5565 Pk	28.00 CHF
Putzrahmen AS = 76 × 76mm	5214 Pk	28.00 CHF
Einbaubox 190 × 145 × 85mm	5202 Bx	48.00 CHF
Putzrahmen AS = 68 × 76mm	5202 Pk	36.00 CHF
Einbaubox 370 × 145 × 85mm	5205 Bx	52.00 CHF
Putzrahmen AS = 68 × 220mm	5204 Pk	42.00 CHF

Alle Preise excl. MwSt.

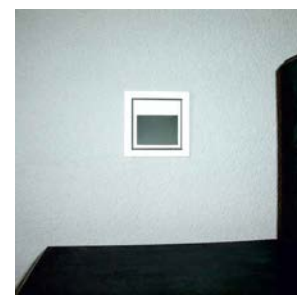

Plasterkit aus Lochblech muss bis zum Ausschnitt der Leuchte ganz verputzt werden. Siehe Bildanordnung.

Wandeinbau Trittbeleuchtung

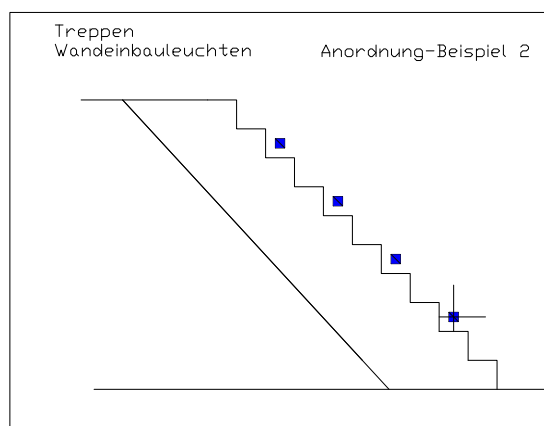
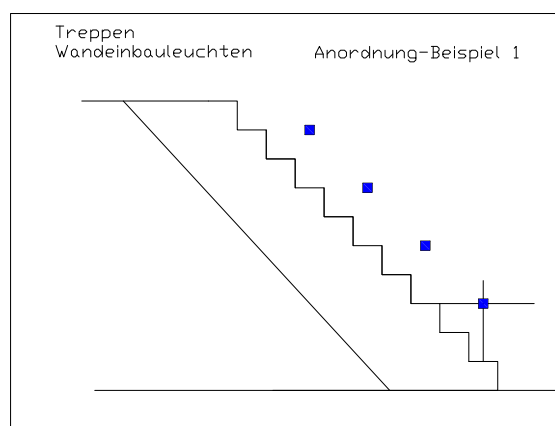

Kabelverbinder



IP68 2polig



IP68 3polig

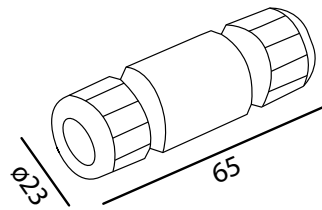

IP68 4polig

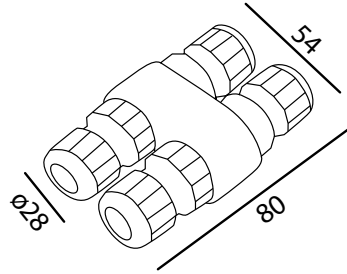

00005-10	Kabelverbinder Schraubanschluss IP68 2polig	# 16.75 CHF
00005-11	Kabelverbinder Schraubanschluss IP68 3polig	# 16.75 CHF
00005-12	Kabelverbinder Schraubanschluss IP68 4polig	# 42.00 CHF
00005-13	Blende	# 3.00 CHF

Alle Preise excl. MwSt. und VRG.

Sonderrabatt

Kabelverbindungen IP68

Kabelverbindungen absolut wasserdicht. Geeignet für einfaches Verbinden im Aussen-/Nassbereich.

Hülle aus Nitrilkautschuk und Silikondichtung. Die Klemme ist geeignet für Litze und Draht.



Kabelkupplung



Schraubanschluss 2polig



Schraubanschluss 3polig

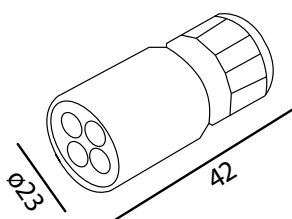

Kabelkupplung IP68

Neue Kabelverschraubung mit folgenden Vorteilen:

+10 mm lang: mehr Innenraum für die Verdrahtung von Kabeln.

Maximaler installierter Kabeldurchmesser 14,0 mm

Absolut Wasserdicht.

00005-01	Rundstecker mit Kupplung IP68 2polig	# 20.50 CHF
00005-02	Rundstecker mit Kupplung IP68 3polig	# 20.50 CHF

Alle Preise excl. MwSt. und VRG.

Sonderrabatt

